

**APPLICATION OF LEAN MANAGEMENT PRINCIPLES TO
ELECTION SYSTEMS**

by

Tomer Posner

B.S., Biomedical Engineering

Yale University

Submitted to the Department of Mechanical Engineering
in Partial Fulfillment of the Requirements for the Degree of
Master of Science in Mechanical Engineering

at the

Massachusetts Institute of Technology

February 2006

© 2005 Tomer Posner
All rights reserved

The author hereby grants to MIT permission to reproduce
and to distribute publicly paper and electronic copies of this thesis document
in whole or in part in any medium now known or hereafter created.

Signature of Author.....
Department of Mechanical Engineering
December 20, 2005

Certified by.....
Ted Selker
Associate Professor, MIT Media Lab
Thesis Advisor

Certified by.....
Thomas Sheridan
Professor of Mechanical Engineering
Thesis Supervisor

Accepted by.....
Professor Lallit Anand
Chairman, Department Committee on Graduate Students

(this page intentionally left blank.)

APPLICATION OF LEAN MANAGEMENT PRINCIPLES TO ELECTION SYSTEMS

by

Tomer Posner

Submitted to the Department of Mechanical Engineering
on December 20, 2005 in partial fulfillment of the requirements for the
Degree of Master of Science in Mechanical Engineering

ABSTRACT

Lean was first adopted as a management technique for improving results in manufacturing environments. It is based on the 5 principles of identifying the *Value* to be created, mapping the *Value-Stream* (incremental addition of value), ensuring process *Flow*, orienting the process towards the *Pull* of the customer and finally eliminating all *Waste* through a process of continuous improvement. This framework is highly adaptable, and has been applied in recent years to non-manufacturing efforts, such as product development and the retail and service industries.

We explore the application of Lean to voting. Applications can be found in the phases of technology development, production, deployment, poll management and more. By following a structured approach based on Lean, the efforts to advance voting solutions in the US can gain in efficiency, security, privacy and credibility over their current state. These will be adapted to deal with the voting environment, which imposes a unique set of challenges and follows priorities different from normal corporations. Additional Lean elements, such as eliminating irregularities through standardization, improved training and process transparency will be reviewed.

The development and deployment of Brazilian voting system will be presented as an example of how Lean elements can be used in the voting setting. While not intentionally created by the Lean model, the design, deployment and current use of the Brazilian system is highly complimentary to this model.

Finally, we suggest ways in which such an approach can be applied to the U.S. voting system. With a theoretical structure in place, specific improvement efforts can be devised and applied in the field. This study, therefore, is intended as a preliminary effort of identifying a problem and modeling it. It hopes to induce a commitment to Lean which will put in motion a cycle of implementation, elaboration and continuous improvement.

Thesis Advisor: Ted Selker
Title: Associate Professor, Media Lab, MIT

Thesis Supervisor: Thomas B. Sheridan
Title: Professor of Mechanical Engineering, MIT

(this page intentionally left blank.)

ACKNOWLEDGEMENTS

I would foremost like to thank my parents, Orna and Elieser, for providing me with the opportunity to pursue my goals and for their love and affection, which has helped me through the most trying times. Equal gratitude goes out to my siblings, Gallia and Nimrod.

Special thanks to my cousin Yoni, for his positive attitude and support here in Cambridge. I truly enjoyed the time we spent living together.

I would like to thank my advisor Prof. Ted Selker for his guidance and constant motivation that has enabled me to complete my research work. I would also like to thank him for the opportunities that he has made available to me.

I would like to acknowledge Professors Stephen Graves and Thomas Sheridan for their insights and input into this project.

Finally, a last hoorah to Jonathan Goler for setting the rusty wheels in motion that got this thing rolling in the first place.

TABLE OF CONTENTS

ABSTRACT.....	3
ACKNOWLEDGEMENTS.....	5
TABLE OF CONTENTS.....	6
LIST OF FIGURES	8
Chapter 1 – Current Difficulties in U.S. Election Management.....	9
1.1 Introduction – Background and History	9
Chapter 2 – Introducing Lean	13
2.1 The Lean Model Proposal.....	13
2.2 A General Adaptation of the Lean Model to Voting Systems	15
Chapter 3 – The Brazil Model	21
3.1 Introduction – Motivation and Background.....	21
3.1.1 Brazil and the Democratic Process	21
3.1.2 Introduction of Electronic Voting in Brazil	22
3.2 Brazil’s Electronic Voting Machine Project.....	26
3.2.1 Strategic Planning.....	27
3.2.2 Defining Needs and Evaluating Tradeoffs.....	28
3.2.3 The Public Bidding Process – Call for Proposals	33
3.2.4 The Public Bidding Process – The Winning Proposal.....	36
3.2.5 Development of the Hardware and Software of the Voting Machine	39
3.2.6 Production and Quality Control.....	44
3.2.7 Deployment and Use.....	46
3.2.8 Public Education and Awareness.....	48
3.3 Feedback, Lessons Learned and Further Development	50
3.3.1 Issues with System Security.....	51
3.3.2 Outstanding Issues and Problems	52

Chapter 4 – Elaborating the Lean Election Model for the U.S.....	53
4.1 Methods of Applying Lean	53
4.2 Applying Lean to US Voting Administration – Divide and Conquer	56
4.2.1 Committing to Lean	56
4.2.2 The Technology Value Stream	57
4.2.2.1 Improving the Product Value-Stream	57
4.2.2.2 Low Error Voter Interfaces and Verified Voter Trails	59
4.2.2.3 Secure Architecture for Voting Electronically	60
4.2.3 Lean Applications to the Poll Management Value Stream.....	63
4.2.4 The Public Relations and Interface Value Stream	68
4.3 Continuous Improvement and Six-Sigma.....	70
Chapter 5 – Conclusions	73
REFERENCES	74
APPENDIX A – BRAZIL VOTING SURVEY	77
APPENDIX B – THE LEAN ENTERPRISE MODEL.....	81
APPENDIX C – LEVI ELABORATED	85

LIST OF TABLES

Table 2-1	Values Pertinent to Voting	17
Table 3-1	Comparison of Voting Machine Prototypes	30
Table 3-2	Timeline of Voting Machine Delivery by Unisys Brazil	35
Table 3-3	Voting Machine Proposals of the Three Major Bidders	38
Table 3-4	Cumulative Voting Machine Data (Brazil)	50
Table 4-1	Differentiating Factors (Brazil vs. US)	54

LIST OF FIGURES

Figure 3-1	Mechanical Card-Punch Machine	23
Figure 3-2	Schematic of the Voting Machine Project	26
Figure 3-3	IBM's Voting Machine Prototype	36
Figure 3-4	Procomp's Voting Machine Prototype	37
Figure 3-5	Unisys's Voting Machine Prototype	37
Figure 3-6	The Unisys Electronic Voting Machine (2002)	40
Figure 3-7	The VM User Interface	43
Figure 4-1	Roadmap to Lean	55
Figure 4-2	LEVI vs. Sequoia Errors	60
Figure 4-3	The Voting Deployment Value Stream	65
Figure 4-4	Andon Boards	68

Chapter 1

Current Difficulties in U.S. Election Management

1.1 Introduction – Background and History

The voting process is considered by most as the centerpiece of democracy. The contribution of citizens in electing officials and deciding on important matters has been strongly fought for and defended in civil movements and wars throughout history. The turbulence rarely ended once the right was secured. It continued to manifest itself in the debate on the methods of conducting the rite itself.

Entering the 21st century, technology has reached a level at which it can immensely simplify the voting process. Government, academic and private institutions are all in a frenzy to develop and introduce new technologies to address the need for more secure, reliable, accessible and efficient elections. However, the multitude of available technologies of various levels of maturity has met an elections system that is ill-prepared to receive it. Additionally, a lack of planning and goal setting has left engineers developing the future face of voting. Preferably, government and lawmakers should be defining the needs of democracy and use the engineers' help to bring forth technological solutions to meet these goals.

From the technical standpoint, the day is near where citizens could show their support or dissent on a weekly or daily basis. In the UK, cellular-phone based voting has been attempted [1] and in the U.S. several states have implemented internet voting for primary elections [2]. Such technologies offer sustainable platforms for fast-turnover voting. Citizens could be allowed a voice on public referendums, legislature, and impeachment processes, to name a few. One can appreciate the effects of technology can go beyond making processes more efficient – they can enable political and social practices that have previously been regarded unthinkable.

In this work, it will be assumed that current trends in the United States are to be maintained. That means voting is conducted in centralized locations at two year intervals. Voting technology in the US received a sizeable boost of monetary and political resources following the incidents of the year 2000 Presidential elections. As a result, by the 2004 Presidential elections, 20% of U.S. counties had deployed Direct Recording Electronic (DRE) voting machines. These machines allowed as many as 29.5% of eligible voters in the U.S. to vote electronically [3].

On its face, the progress has been positive and was conducted in good stride. While public opinion of electronic voting and its implementation varies [4], no major glitches have occurred thus far with the new technologies.

Upon closer inspection, however, the picture is not so pretty. Abundant literature exists [5] [6] criticizing virtually all elements of voting in the US – from the voting machines, to voting administration, to jurisdiction and oversight. The observations made put in question voting security, reliability, accuracy as well as describing voter dissatisfaction, lack of trust and inconvenience. This is after over 3 Billion US\$ have been invested in recent years by public and private institutions in improving voting technology.

This thesis suggests a new approach to the administration of elections and election technology in the US. This approach is based on Lean Principles, initially formulated for manufacturing industries. Facing the challenges of administering efficient, cost-effective, secure and painless elections will be addressed in terms of defining and augmenting *value*, removing *waste*, introducing *standardization*, activating *flow* and *pull* and seeking *perfection*.

The transition from paper to electronic voting in Brazil will be used as an example of a well structured process of creating an effective and sustainable voting solution. The report will focus not only on the voting machine itself, but on the process as a whole – from the legislative validation of the transition, to the development phase and finally to

deployment and use. While not intentionally conducted according to Lean principles, the process does conform to the Lean model.

With this validation of the Lean approach, the thesis will move on to lay out the ways we hope to apply it in voting. We should note, however, that our use of Lean might have to differ slightly from that of conventional industries. The reason is that we must reprioritize our goals and values as compared to a commercial corporation. Nevertheless, Lean's inherent focus on reliability, timeliness and the human factor should compliment voting quite well.

(this page intentionally left blank.)

Chapter 2

Introducing Lean

2.1 The Lean Model Proposal

Lean was first introduced by James Womack, Dan Jones and Daniel Roos in their book “The Machine That Changed the World” published in 1990 [7]. It is based on the largest and most thorough study ever undertaken in any industry – the MIT five-million-dollar, five-year, fourteen-country International Motor Vehicle Program’s study of the worldwide auto industry. The book brought forth many insights as to differences between traditional mass production employed by the West (US and Europe) and Toyota’s highly efficient production system.

The Lean model set forth by Womack, Jones and Roos can be summarized as follows. Organizations must define the **value** that they produce as the product that best suits their customers’ needs. They must then identify and clarify the **value stream**, the chain of actions that bring the product through design, engineering, planning and production tasks. Next, the *Lean enterprise* should line up its suppliers with this value stream. In execution, **flow** must be maintained ensuring uninterrupted value aggregation. **Pull**, or the constant adaptation of the organization to the customer’s needs, should be the driver of the process. Finally, with the entity reengineered toward the creation of value, it should seek to achieve "**perfection**" through continuous improvement, rooting out all the remaining *muda* (Japanese for "**waste**") in the system.

Since the publication of this book, many research and consulting groups have continued to elaborate the initial Lean model. One of the most exhaustive efforts has been conducted by the Lean Aerospace Initiative (LAI) at MIT. This group of academicians, supported by government and aerospace company grants, has evolved Lean models applicable not only to production and manufacturing, but for large multi-faceted companies. The Lean Enterprise Model (LEM) takes in mind the largest of aerospace

consortiums in the world, and lays out a distinct structure that promotes Lean improvement. It also structures a roadmap for enterprises to follow on their pursuit of Lean. I will return to the LEM proposal in Chapter 4 of the thesis, where the methodology of applying Lean will be discussed.

It should be noted that other highly qualified analyses of the Toyota Production System have been performed, producing sets of guidelines both competitive and complimentary of Lean. An example is Spear and Bowen's study "Decoding the DNA of the Toyota Production System" [8]. The authors present a study of TPS which produces the following four rules:

These rules guide the design, operation, and improvement of every activity, connection, and pathway for every product and service. The rules are as follows:

- Rule 1: All work shall be highly specified as to content, sequence, timing and outcome.
- Rule 2: Every customer-supplier connection must be direct, and there must be an unambiguous yes-or-no way to send requests and receive responses.
- Rule 3: The pathway for every product and service must be simple and direct.
- Rule 4: Any improvement must be made in accordance with the scientific method under the guidance of a teacher, at the lowest possible level in the organization.

Spear and Bowen [8]

The thesis will pursue the Lean model because of the well structured process it affords and its adaptability to non-manufacturing environments.

2.2 A General Adaptation of the Lean Model to Voting Systems

Applying the Lean Model to Voting

In order to apply the Lean model to voting, we must identify the real-world manifestations of each of its principles. Once we have a conceptual model of voting in the familiar Lean framework, we will be better prepared to reevaluate the process and realign it in search of our goals.

At this point it is important to address said goals of the voting process. Obviously, any arbitrary definition here will invoke a heated debate. In the corporate world the ultimate goal is increasing shareholder value. Value for other stakeholders – employees, customers and society in general (and in that order, usually) – comes in a close second. In the voting scenario, the roles reverse significantly. The interests of society come to the frontline, expressed in a secure and reliable voting process. Next come the customers, or citizens, expecting convenience, ease of use and privacy. The employees are to be well coordinated and trained to ensure a smooth democratic process. Finally, shareholder value or cost-benefit considerations tend to be regarded as enabling factors rather than goals to be achieved.

This modified set of goals doesn't exclude the use of the Lean model for voting. It simply requires us to ask different questions throughout our evaluations. For example, not only should enforcing standardized practices be used to reduce costly errors and improve quality, but also to reduce miscounting errors and improve polling efficiency. In fact, the Lean model has already been adapted to various non-commercial environments. For example, GM taught value-stream mapping to the staff at a Michigan State Police crime lab in a successful effort to cut the time needed to analyze evidence¹. The Lean

¹ *GM helps nab bad guys through DNA evidence.* The Detroit News, October 17, 2004. "In Michigan, a unique partnership between the Michigan State Police and General Motors Corp. is making it possible to more quickly track killers, rapists and other criminals through DNA evidence. Federal grants and a fresh business approach used by GM have enabled crime lab scientists to reduce a 10-year backlog to less than a year and make nearly 10 times the matches of known criminals to evidence left at crime scenes. [...] Police had heard about a GM system called value stream mapping to identify, assess and solve workplace problems and meet goals."

model can be used to attain non-monetary goals and needs, as long as they are carefully defined and clear to all stakeholders.

Finally, an enabling factor throughout the process of creating a Lean system is ensuring participant buy-in. This is probably the single most important and most challenging aspect in the creating of a Lean voting system. Buy-in must be assured at all levels if this approach is to succeed – from politicians, to academics, to corporations to the general public. Voting is a national interest for a democratic society, and national buy-in must be ensured to support it.

Identifying Value

The first step in applying Lean is identifying the *Value* we are trying to create. However, before we do so, we must define a product towards which we are applying our effort. Let us assume we are producing votes. Each vote should be cast by a single eligible citizen and should result in a unit increment on the final ballot count. However, by simply creating this product we are doing only half the work. Doing so would be analogous to a car manufacturer producing cars and stocking them up unsold in the dealer parking lots. In the same way, the responsibilities of the voting system go far beyond the creation and counting of single votes.

So while it's important to always keep in mind the product we are producing, it's important to focus our activities on the creation of *Value*. For our purposes, we will use a set of parameters that are widely used to evaluate voting systems that were assembled by members of the MIT Voting Technology Project. The values we are trying to create from the pure voting standpoint are shown in Table 2-1 below.

Value	Implication
Inclusion of Citizens	Ensuring high voter turnout.
Accessibility	Easy to register and vote, regardless of physical limitations.
Vote Security and Privacy	Both at time of voting and by using untraceable ballots.
Positive Poll Environment	Timely and convenient voting.
Reliable Results	No fraudulent votes, no votes left uncounted.
Auditable Results	Traceability, whether electronic or physical (paper trail).

Table 2-1 – Values Pertinent to Voting

Assembled by members of the MIT Voting Technology Project

To these we must add measures of value that surface for other stakeholders in the value stream. For example, OEM’s will see their profits and low service costs as important values. The taxpayer sees economical solutions as valuable. The poll worker sees appreciation of her work and decent pay as important values.

Mapping the Value Stream

Before we attempt to introduce improvements to a system, we must have clear knowledge of the processes that drive it. The *Value Stream*, the chain of actions that contribute to the value of the final product, must be defined for each of the central processes that define voting. Since voting is not a physical product, it is not always evident how value is being added to it. An example of a voting value stream that describes the deployment and management of polling locations (Figure 4-3 in Chapter 4) shows that at many points value is being added in the form of information (votes) or ideas (ballot design). This is in opposition to a manufacturing line, where the value stream can clearly map out the physical transformation of raw materials into a finished product.

Therefore, Value Streams in the voting context should be used as conceptual guidelines on the basis of which actual policies and procedures can be formulated. Their creation helps in visualizing the current state of a system and describing the major linkages in the system – locations where Lean experts would try to improve flow and coordination. To fully achieve this and efficiently run the value stream, Lean calls for just in time supply management, standardization of practices, constant process feedback and transparency. How would these play out in voting?

In the technology value stream, for example, suppliers must be better integrated and encouraged to become partners in achieving Lean goals. The interests of suppliers and government which are usually considered opposed can be shown to coincide. Take for example suppliers of Toyota, the kingfish of Lean manufacturing. Their success depends on Toyota's financial success. Toyota's success relies on a timely supply of quality parts from its suppliers. In the same way, government agencies should create mutually supportive relationships with voting technology companies. The success of new technologies will reinforce public opinion about electronic voting and will drive further progress. At the end of the day, the public enjoys the benefits of well executed voting technology and government agencies benefit from lower administrative and cost overheads and the higher credibility of the voting system.

An important aspect of defining the Value Stream is ensuring all the stakeholders in the process are aware of it. In other words, we seek to increase the transparency of the process. This step has the effect of increasing the understanding of the system and confidence in the system, further helping in its improvement.

Improving Flow

Once the value stream is established, we can start working on improving *Flow*. Flow entails both lining up suppliers with the value stream, as well as internally assuring the efficient and uninterrupted addition of value. Suppliers of voting technology should be

well informed of expected production requirements and timelines, yet ensure standardization and quality to ease deployment at voting centers. Internally, government agencies to poll workers should create standardized procedures to facilitate improvement and implementation of lessons learned.

Submitting to Pull

In a Lean system, the driver of the entire process is *Pull* – or the needs of the end users. In the case of voting, this would be the expectation of voters that voting values (see Table 2-1) are being met by the election system. The voting systems produced should match and not exceed demand. They should offer interfaces deemed appropriate by voters, not by developers. Election results should be processed and distributed promptly. The consumer of voting is the ordinary citizen, and answering his or her needs is the purpose of the voting process. Therefore, the technology offered should meet the requirements of voters, and not be a tour-de-force of rivaling voting technology manufacturers. Machines should be ranked in reference to reliability, security and usability, and not by LCD screen size, colors, touch-screen capability or processor speed. They should get the job done, and get the job done well.

Seeking Perfection and Achieving Predictable Sustainable Results

Finally, with value and value stream defined, flow and pull ensured, the process can be constantly reengineered towards *Perfection*. This will be done by constantly reviewing the established practices and eliminating all of the remaining *muda* (Japanese for "waste") in the system.

One of the pivotal ways of eliminating waste in the process is by reducing unintended variation. While not one of the five basic elements of Lean, reducing variation is key to eliminating waste in the process and streamlining flow. Selker [9] carefully surveyed multiple election sites during the 2002 and 2004 elections, finding large amounts of variation in polling site management. Not surprisingly, these locations displayed varying levels of performance in terms of up-time, reliability of vote registration and overall voter

experience. Straying from standardized procedures was closely followed by straying in performance.

The widely varying legislation, voting practices and voting procedures across regions and states in the U.S. might suggest that introducing standardization in voting would be difficult. However, if we take a look at the automotive industry we will notice it deals quite well with requirements for customizable products (whether to country regulations, environmental requirements or market preferences). Standardized procedures and technologies, therefore, do not preclude a highly flexible and adaptive system. What more, automotive companies such as Toyota have proved this flexibility to come at very competitive price.

So while differences in requirements of voting systems across precincts, cities and states are hard to bridge, a standardized system can still handle them, as long as it is customizable. Just like a manufacturing organization has standardized practices but can still create a variety of products and models, election systems must be efficiently standardized yet adaptable. The system changes required to reach better uniformity might require additional investments, yet these will often be offset through economies of scale.

The benefits of standardization are recognized when the system is driven to improvement and higher efficiency. The lessons learned over time are easier to apply system-wide if practices and technologies are standard. As each problem is encountered, a single solution should be applicable if a standardized system is in use. The value is also significant in the training phase of poll workers, as common content can be better controlled and standard procedures more readily overseen.

Chapter 3

The Brazil Model

3.1 Introduction – Motivation and Background

To demonstrate these concepts of value, value stream, flow, pull, eliminating waste and seeking perfection, we will engage in a careful examination of the process that brought about the Brazilian electronic voting system. In 1996, it was the first nation-wide implementation of such a system, and its technical development is highly reminiscent of the Lean approach. After a brief introduction to Brazil and its voting system, this chapter reviews each major step in the design, development, production and deployment of the system and shows what it can teach us about applying Lean to voting.

3.1.1 Brazil and the Democratic Process

Election-day in Brazil is always a national holiday. Elections are held every 2 years on the first Sunday in October and runoff second rounds on the last Sunday of October.

Voting is considered both a right and a duty in Brazil. Accordingly, registration and voting are compulsory between the ages of eighteen and seventy. Illiterates vote, but their voting registration card identifies their status, and they sign the voting list with a fingerprint on election-day. The 1988 constitution made it possible for 16 and 17 year olds to vote on a voluntary basis. In 1994 these young voters totaled 2,132,190 (2.2 percent of the electorate). For these reasons, turnouts for all elections in Brazil are very high, usually as much as 80%. [10]

Brazil has four types of majority elections: the president, governors, and mayors are elected by absolute majorities; senators, by simple majorities. In elections for president, governors, and mayors of cities with more than 200,000 voters, a runoff is required

between the top two candidates if no one receives an absolute majority in the first round (50 percent plus at least one vote). State and national elections (for president, state governors, and Congress) are two years out of phase with municipal elections. All posts are for 4 year terms.

The elections in Brazil are governed by the Superior Electoral Court (or TSE - *Tribunal Superior Eleitoral*). The government of Getúlio Vargas created the TSE in 1932 in an effort to end election fraud and manipulation. The TSE has jurisdiction over all aspects of elections and regulates the functioning of political parties. Its powers include supervising party conventions and internal elections; granting or canceling registration of parties; registering candidates and certifying those elected; regulating and supervising party access to free television and radio time during an election; and registering voters [11].

In this context, the TSE's has complete control over voting technology, voting procedures, and polling procedures. It is responsible for collecting, aggregating and publishing local, regional and national election results. Every state has a Regional Electoral Court (or TRE – *Tribunal Regional Eleitoral*); larger cities have municipal election judges, and smaller towns have local election boards. The execution of the TSE's procedures is siphoned down to these outposts.

3.1.2 Introduction of Electronic Voting in Brazil

Brazil was the first country to adopt a nationwide electronic voting system. The voting system integrates voter registration, the casting of votes and the summation of votes regionally and nationally. Brazil is currently the only country to have such a computerized integrated system in normal operation as the sole method of collecting and counting the peoples' votes. Furthermore, its deployment was done through a transparent publicly viewable process.

In the U.S., many mechanical voting machines had been adopted during the 20th century. As a result, a myriad of mechanical systems, which all print or punch on paper are deployed throughout the nation. In Brazil there was no adoption of such technologies. As a result, the first deployment of electronic voting met few hurdles – its performance had to exceed only that of paper slips and ballot boxes. Nevertheless, some early attempts and regional efforts are worth mentioning, as they serve as background for the revolution in voting technology of 1996.

First mention of using technology in voting was made in the first Brazilian Election Law of 1932, predicting the use of a voting machine. In the 1960, the inventor Sócrates Ricardo Puntel presented the mechanical card-punch machine shown below (Figure 3-1). The solution was not considered efficient – manual counting was still necessary, and the capital investment was frowned upon – resulting in the abandonment of the project.

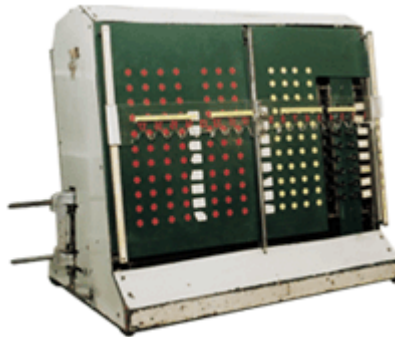

Figure 3-1 – Mechanical Card-Punch Machine
Introduced by inventor Sócrates Ricardo Puntel in 1960,
yet never put to use

What followed, in the late 70's and early 80's, were initiatives taken on by various states in Brazil. These efforts were localized and not centrally coordinated, but nevertheless provided experience and knowledge later implemented in the national system. These include a prototype for mechanized voting presented to the TSE by the TRE of the state of Minas Gerais (southeast Brazil) and various attempts of automating the registration process. In 1983, the TRE of the state of Rio Grande do Sul became the first to make an electronic record of its registered voters.

Motivated by these initiatives, in 1985 the TSE created an electronic national register of voters for the upcoming 1986 state elections. Each voter received a Voter's Card, printed with their name, ID number, voter number and voting location. These have similar function to the Voter's Registration cards U.S. citizens receive at their home addresses. The responsibility of transcribing voter information, validating it, and issuing voter's cards were subcontracted to 3rd parties. Completed in late 1986, the project resulted in a consolidated record of Brazil's 70+ million eligible voters.

The next milestone achieved by the TSE was automating the counting, consolidation and transmission of voting results. Under this scheme, votes counted manually at the ballots would be summarized in written reports submitted to local transmission points. From that point on the information would be processed and transmitted digitally to TRE's and finally to the TSE. The regional (TRE) and national (TSE) agencies would each publish real-time data reports to the press in 15 to 30 minute intervals.

To support the process of transmission and consolidation of votes, the TSE created a network of 4,530 desktop computers linked using telephone or data lines to 11 regional mainframe units, and 7 mainframe units in the TSE center in Brasilia. The system was put to national use in the 1994 national elections. The field was then set for the final stage of creating a fully automated electronic voting process.

In the next section, I will review the process that gave birth to the electronic voting machine. Requiring a mere 20 months from first deliberations to use in national elections, the project was an amazing political, judicial, managerial and engineering feat. At the same time, concessions had to be made, and their repercussions will be analyzed.

While the technological solution will be reviewed as part of this discussion, this review does not aspire to give a full, up-to-date description of Brazil's voting machine technology. Such reports can be found elsewhere [12], or on the TSE's website (<http://www.tse.gov.br>). In our efforts to apply Lean to voting, our focus will be on the

process by which the voting solution was developed, produced, distributed and implemented. After each major step in the process, a dedicated section reviews its relevance to the Lean model. Thus, we can use the Brazil process as a backdrop for implementation of a Lean system in the US.

3.2 Brazil's Electronic Voting Machine Project

The following section will follow the timeline of planning, development, contracting, production, deployment and use of the electronic voting machine in Brazil. The process was orchestrated by the head of the TSE, Minister Dr. Carlos Mário Velloso, and the head of Information Technology at the TSE, Dr. Paulo Cesar Bhering Camarão. Below (Figure 3-2) is an adapted flow chart of the project based on the schematic given in a book by Dr. Camarão “*O Voto Informatizado: Legitimidade Democrática*” (Computerized Voting: A Democratic Legitimacy) [13]. The ensuing process description is also heavily based on this manuscript.

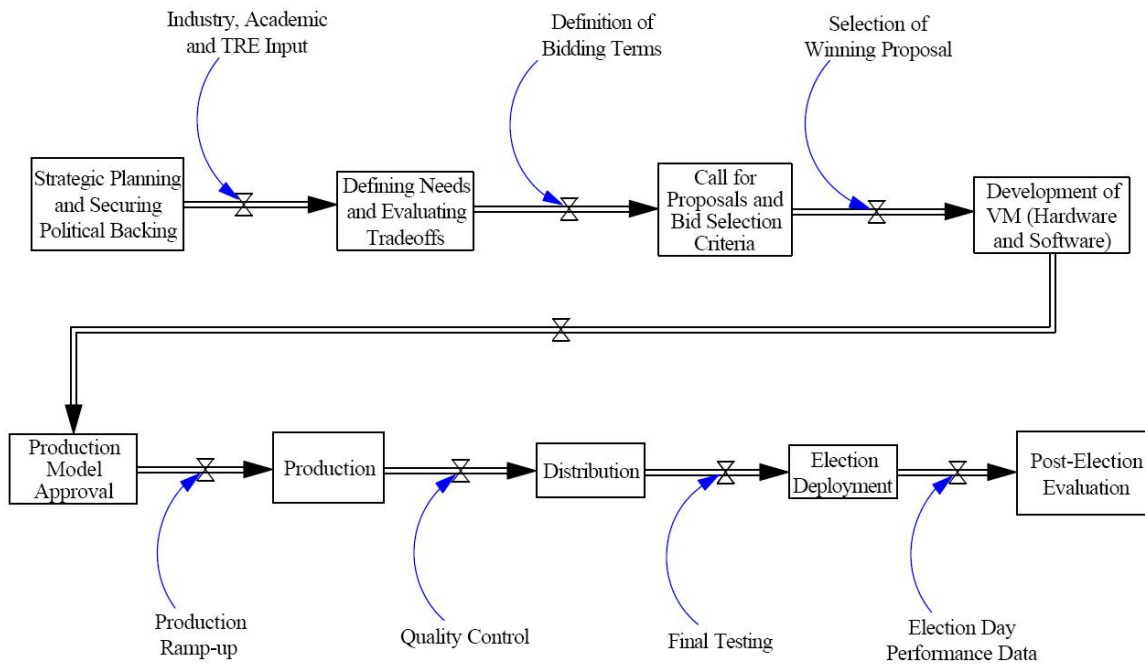

Figure 3-2 – Schematic of the Voting Machine Project
Adapted from “O Voto Informatizado” by Dr. Paulo Camarão [13]

3.2.1 Strategic Planning

This first step in the development process was in effect an effort to gather support across the board for the program. This involved lobbying of politicians with executive and legislative powers, as well as organizing the management and oversight of the program within the TSE. At the same time, a publicity effort was launched to inform and ready Brazilian citizens for the upcoming change in the way they vote.

The leaders of the TSE established the main goals of the program, which were to be referred to throughout the development, bidding, acquisition and deployment phases of the project:

1. The system will allow a fully automated/electronic voting experience – from the voting itself, to the counting, to the forwarding of results to the central national database.
2. The system will be deployed throughout the country for the 1996 municipal elections, meaning it will be available in at least all the capitals of Brazil's states.
3. The equipment should be impervious to fraud, and should allow auditing of its function.
4. The system (equipment, programs and processes) should be transparent and gain the approval of citizens, political parties and candidates.

<i>LEAN: Strategic Planning</i>
--

Careful planning is a condition for the success of any project. From the Lean perspective, planning ahead reduces **waste**. Mediocre planning results in processes that fail to add value and in result in unnecessary revisions that take up valuable time and resources. Therefore, careful planning is essential even as one is about to embark on developing solutions. In this case, strategic planning helped assure broad support and good communication among stakeholders in the upcoming effort.

3.2.2 Defining Needs and Evaluating Tradeoffs

An elaborate, yet extremely efficient process was used to define the needs and general requirements of the new voting machines. While primarily an engineering challenge, the process began with joint efforts of politicians, legal specialists and engineers. These formed a group – The Commission for the Automation of the 1996 Municipal Elections) – that met regularly between April and August of 1995, giving forth to the following reports:

Reference Draft of Needs and Requirements

This first deliverable elaborated on the four points of the strategic plan. It is an initial draft of needs and requirements the system was projected to meet:

- The cost of the equipment should be in line with the budget of the TSE.
- The system's versatility should allow it to be used outside of election times.*
- The system must not create new obligations for the voter, and it should be useable by individuals of all intellectual and physical capabilities.
- Identification of the voter should be by way of a valid document, in the purpose of limiting fraud and ballot-stuffing.
- When voting for a candidate, the voter should also be allowed to vote by way of writing down the name of the candidate.*
- The system should guarantee the confidentiality and authenticity of the vote, and be resistant to manipulation.
- The option to recount votes and audit the counting should be maintained.
- The voting equipment should guarantee a reliable and uninterrupted voting experience, throughout the election period, with no loss of registered votes.
- The voting equipment should be easy to install and maintain.
- The voting equipment should allow immediate counting and aggregation of votes after the closure of the ballots.

* – these items were excluded later in the development process due to impracticality.

Supporting Legislation

In parallel, an effort was made to adjust the Brazilian Elections Law to accommodate the new system. While the items of this legislature merely reflect the expected performance and accessibility of the system, what should be noted is the relative ease in which this more “political” step was accomplished. This speaks well of the buy-in achieved across the board by the project leaders.

Plenary Decisions

During the months of May through August, the Commission furthered the concept of the new system. As a first step, it gave a go-ahead to various interested parties to start developing concepts for the voting apparatus. Such prototypes were to adhere as much as possible to the Reference Draft drawn above. Next, it secured funding from the TSE for further development of prototypes that best met its criteria.

Four TRE’s (regional elections committees) and 2 private companies presented concepts and models to the Commission. Two of the solutions stood as the most mature designs. As can be seen in Table 3-1, they each answer a different subset of initial requirements. The final product ends up as a combination of these two proposals:

	Solution by TRE of Minas Gerais	Solution by TRE of Mato Grosso	Final Production Model
Has a low estimated cost	X		X
Can be used throughout the national territory	X	X	X
Versatile – can be used outside election periods		X	
Can function on batteries alone	X		X
Supports Numeric voting	X	X	X
Supports Alphabetic voting		X	
Simple to use	X		X
Guides user with sound messages		X	
Shows visual representation of chosen candidate		X	X
Guarantees vote confidentiality	X	X	X
Robust	X	X	X
Easy to install, store and transport	X	X	X
Allows immediate counting of votes	X	X	X
Issues a ballot report at the end of voting	X	X	X
Issues physical evidence for each vote	X	X	X
Allows transmission of votes over network		X	

*Table 3-1 – Comparison of Voting Machine Prototypes
The Minas Gerais and Mato Grosso VM prototypes (August 1995)
vs. the final production model (October 1996)*

Commission’s Final Report

The Commission issued its report at the end of August of 1995, giving its final criteria, observations and guidance. This report formed the basis for the ensuing competitive concept and business-plan generation phase. The following list is a summary of the principle requirements of the new voting system. Since these are meant as conceptual guidelines, they do not define the technical solutions but rather the needs the engineers should address in their designs.

The equipment should...

1. be easy to install.
2. be easy for voters as well as reception attendees to operate.
3. have a low cost. Bidders should adhere to their initial proposal price allowing for minor design modifications during development.
4. have an independent energy supply for the case of power shortage.
5. be robust.
6. be controlled remotely from the reception desk in a way that the voter will vote only once.
7. issue physical proof of the vote which should contain the candidate's name, number and political party.
8. collect the physical proof of the vote without intervention of the voter.
9. allow future updates and upgrades at competitive costs.
10. have a screen that allows easy review of the ballot and other information.
11. be made available in sufficient quantities to allow testing, and later for training of voting attendants and the general public.
12. display the picture of the chosen political candidate when the voter is asked to confirm their vote.

General Technical Considerations

In addition to the recommendations above, the meetings of the IT team resulted in additional observations regarding the engineering solution. These pertain to engineering trade-offs, directly affecting security, accessibility, lead-time and cost. Interestingly, they have much in common with the dilemmas facing developers of American voting technology today. Their solutions, however, are highly dependant on the cultural, economic, political and technological conditions at the time and place that they are being considered.

Installing the list of registered voters list on the voting equipment – Installing the voters list on the machine would facilitate voter identification, as well as prevent voters from voting more than once. At the same time, it is likely to increase the cost of the system.

Numeric or alphanumeric voting – Numeric voting (voting by way of a numeric code unique to each candidate) simplifies the necessary equipment and makes it easier for illiterates to vote.

Networked or isolated hardware – A networked solution reduces costs and simplifies the voting units. Networked units introduce risks of communication faults, complicate use in remote areas and require more complex installation (as of 1995, when wired and wireless networks were not as developed as they are today).

Physical proof of vote – While physical proof of votes acts as backup in case of equipment failure and allows easier recounting and auditing, it also considerably raises costs and complexity.

Custom vs. off-the-shelf equipment and technology - Relying on existing equipment and technology lowers costs and lead times, but makes it harder to create a voting solution best adapted to Brazil's election system.

Use outside of election period – If the equipment is made of off-the-shelf components, it might be useable outside election periods, getting better return on investment and saving on storage costs.

The scope of the e-voting solution for the 1996 elections – The more regions to be addressed with e-voting in the upcoming elections, the higher the investment and logistics complexity.

Reducing the number of voting precincts – One would expect that e-voting would allow higher voter throughput per center, allowing the reduction in the number of centers required to address the population. However, due to the groundbreaking nature of this project, this is merely an assumption.

LEAN: Defining Needs and Tradeoffs

Meeting the **needs** of customers or users is the best way of ensuring **pull**. Carefully considering and deciding on **tradeoffs** prevents future redesigns and fixes which **waste** valuable time and resources. By evaluating all these through tightly spaced committee meetings, information is efficiently disseminated to all stakeholders and they are kept focused on the end result and the pathway to achieving it.

When each party knows what information and feedback other parties require, it can align its output to meet those needs. This is the effect of **Pull** in a design environment. For example, establishing the rate of implementation of the new systems over the subsequent elections allowed assemblers to prepare their manufacturing facilities ahead of time. In turn, their suppliers could start preparing to produce the individual parts necessary for the voting machines.

Finally, committee reports and early contacts with suppliers ensured transparency of the process to all parties involved, further improving the **flow** of the process.

3.2.3 The Public Bidding Process – Call for Proposals

In September of 1995, the technical group of the TSE started establishing the technical specifications for hardware and software of the voting machines. They started by soliciting information from universities, regional election offices and private sector companies. One objective of the solicitation was to gather opinions of groups with appropriate technological experience regarding possible solutions. Another was to evaluate the production and deployment capabilities of national and international firms, as a way to ensure the executability of the project.

With the support of the parties mentioned above, the technical group was able to establish the technical requirements in the bidding invitation published in December 1995. The following is a description of key products and services to be supplied by the winning bidder:

Development

Three models are to be delivered by the winning bidder. The first is an **Engineering Model**, to be submitted with the commercial proposal in response to the bidding invitation. This model will serve to verify the technical capabilities of the bidding party. The second is a **Qualification Model**, which makes adjustments to the initial engineering model. The solicitation calls for 10 such units for evaluation purposes. The **Production Model** is the final production version of the voting machine, of which 3 units are to be presented for final approval. The timeline for the delivery of these three models is defined in the chronogram below (Table 3-2).

Training

The supplier of the systems will be required to provide instruction in installation, operation and repair of the units.

Technical Support

The supplier is responsible for training and distribution of some 300 technicians for the upcoming elections. In addition to helping with hardware and software installation, they will be responsible for documenting difficulties and usage statistics to improve the system for ensuing elections.

Guarantee

The system should be guaranteed by the supplier for a period of 30 months starting from delivery of the final production lot.

Transparency

Transparency should exist between the supplier and the TSE regarding hardware and software solutions. The technical team of the TSE reserves the right to solicit alterations in the models and software presented by the supplier. It should also have access to the supplier's facilities for the purpose of product and manufacturing inspections.

Timeline

The estimated timeline for development and delivery of the voting machines is shown in the table below:

Delivery – Day 0 +	Deliverable
15 days	Delivery of Qualification Model
35 days	Delivery of Production Model
60 days	Delivery of 1 st lot of 400 Voting Machines
93 days	Delivery of 2 nd lot of 12,800 Voting Machines
120 days	Delivery of 3 rd lot of 15,000 Voting Machines
135 days	Delivery of 4 th lot of 15,000 Voting Machines
150 days	Delivery of 5 th lot of 15,000 Voting Machines
165 days	Delivery of 6 th lot of 15,580 Voting Machines

Table 3-2 – Timeline of Voting Machine Delivery by Unisys Brazil

Since the contracting “Day 0” was considered March 15th, 1996, this timeline guaranteed production of all necessary VM’s by August 30th, 1996. Actual delivery took slightly longer since the final VM count was 77,459 vs. the projected 73,780, but was still concluded well ahead of the October 3rd, 1996 municipal elections.

LEAN: The Bidding Process

To become Lean an enterprise must seamlessly integrate its suppliers into its **value stream**. In the product development effort, this enables better **flow** of information for a fast and efficient development process. It also reduces the chances of major problems at the manufacturing and distribution stages, allowing tight schedules such as that shown in Table 3-2.

Therefore, instead of reaching a final concept and licensing production out, the TSE had chosen to find a company to partner its effort with. This choice makes a lot of sense, and reflects on how important the project leaders saw good communication between design and manufacturing. Inviting the supplier to be a part of the design and development process is mutually beneficial to both parties, and promises to reduce **waste** of time and resources that come from redesign loops.

3.2.4 The Public Bidding Process – The Winning Proposal

The TSE established a special committee for judging the bids of voting machine suppliers. The international bidding started on February 8th, 1996 when three companies presented their proposals to the TSE. These were:

IBM Brasil Indústria – Maquinas e Serviços Ltda.

Procomp Amazônia Indústria Eletrônica Ltda.

Unisys do Brasil Ltda.

The following are images and brief descriptions of the voting machines submitted by each company:

IBM Model of 1996



Figure 3-3 – IBM's Voting Machine Prototype

This model submitted by IBM was developed at IBM-Japan and was based on a notebook concept. The Brazilian federal government emitted a provisional law at the time that exempted suppliers from paying tax and duty fees for importing and sale of voting equipment to the TSE. This measure was used to encourage a more competitive bidding environment. Had IBM's bid won, the voting machines would have been completely fabricated and assembled in Japan and imported by Brazil.

Procomp Model of 1996



Figure 3-4 – Procomp's Voting Machine Prototype

Weighing in at 55lbs and 4 times the size of the Unisys model, the Diebold Procomp model resembled automated bank tellers. It was, in fact, a common desktop computer and screen encased in a single tin box. The result was heavy and extremely impractical. Diebold-Procomp later created a machine almost identical to Unisys's to win a 1998 bid for 90,000 additional voting machines.

Unisys Model of 1996



Figure 3-5 – Unisys's Voting Machine Prototype

Deliberations included five meetings of the companies with the special committee and the technical team of the TSE. The technical team conducted exhaustive tests on the Engineering Models presented by the competitors. On March 14th, 1996 **Unisys do Brasil Ltda** was chosen as the winning bidder.

The winning bidder was chosen according to a formula that gave equal weight to the technical score and the price of each machine. As all companies had been working together at the technical meetings, it's not surprising the differences in the final score can be mostly attributed to the final price bids rather than technical differences:

	Proposal (in millions)	Score
IBM	R\$ 79.08	9.317
Procomp	R\$ 77.00	9.426
Unisys	R\$ 69.76	10

Table 3-3 – Voting Machine Proposals of the Three Major Bidders

LEAN: Bid Selection

Bidding processes are not very characteristic of Lean. Lean manufacturers, such as Toyota, avoid inducing bidding wars among their suppliers. Instead, they usually stick to highly capable suppliers and maintain long-term working relationships with them, openly sharing technical and business information. This fosters an environment where the parties are mutually financially responsible, information is readily exchanged, designs and specifications rapidly adjusted and effects of general market conditions are smoothed out. In addition, expensive and time-consuming bidding processes are reduced for both sides, eliminating the waste of the two most important resources – money and time.

While confined to the use of a bidding system to secure a supplier, the TSE made the utmost effort to closely follow the development efforts of each bidder. This resulted in 3

highly competitive solutions in a short amount of time. Fortunately, the most practical solution in this case was also the lowest priced.

3.2.5 Development of the Hardware and Software of the Voting Machine

The first model delivered, in accordance with the accepted proposal, was the *Engineering Model*. The Engineering Model was subsequently submitted to field trials conducted by several regional elections offices. The operators as well as voters used in these trials were inexperienced subjects representative of the future users of the system. Based on the trials, recommendations were issued to enhance usability and voter experience. These recommendations were reviewed by technical committees that applied the lessons learned in the Qualification Model and later in the Production Model.

The following is a general description of the hardware and software solutions used in the final Production Model.

Hardware

The voting machines deployed at the polling locations are each built of 3 major components: a **Voter Unit**, **Microterminal** and **Printer**. The **Voter Unit** features a 9.4” monochromatic LCD display with a 640x480 native resolution. It includes a keypad with the numbers 0 through 9 and 3 feature keys: a white “BRANCO” key for registering a neutral vote, a red “CORRIGE” key for clearing entered numbers and a green “CONFIRMA” key for confirming the vote. All the keys are inscribed with Braille for the visually impaired. The pressing of any key results in an audible sound.

Inside, the Voter Unit features a 386SX motherboard with a built in display card, a 40MHz processor and 2MB of RAM. The back panel features a parallel port (for printer and data connections), 2 serial ports and an AC connection. There are 2 disk drives in the voting machine, and they both accommodate 3.5” HD 1.44MB floppy disks. One is considered the “internal” drive, and the other the “external” drive.



Figure 3-6 – The Unisys Electronic Voting Machine (2002)

Pictured are the main Voter Unit (center) which is used by the voter, the administrator's Microterminal (right) used to key in voters' ID numbers, and the ballot printer (left). Note the black plastic bag behind the printer, used to collect the printed ballots.

The internal drive contains the operating system, the voting software, and the database of candidates, political parties and voters of the region. The access to this drive is restricted and requires a key held by the ballot administrator. The developers found this solution convenient, as no copying or special uploading were required by administrators, only the insertion of a floppy disk. The external drive is normally kept empty, and comes into play only at the end of the voting session. When voting is completed at the end of the day and a disk is inserted into the external drive, the machine automatically saves what is called a BU ("Boletim de Urna" – Ballot Report). This report contains a summary of the votes placed for each of the candidates/parties.

Finally, an internal 12V, 6.5Ah battery can sustain the unit in case of a power outage for up to 3 hours. When used in remote areas with no available electricity, a larger external battery is made available (or, as in later models, an internal battery that can support the system for up to 13 hours).

The **Microterminal** unit is connected to the Voter Unit through a long data cable. It is placed on the registration table and remains connected to the Voter Unit which is placed behind a division. The terminal features a numeric keypad and ‘cancel’ and ‘confirm’ keys. The two line LCD display prompts the administrator to enter the voter ID number, shows the voter’s name, and requests the administrator to confirm the entry. The **Printer** is also wired to the Voter Unit, and prints on 3” wide paper. After each ballot is printed, it is cut from the roll and allowed to drop into the ballot bag. The voter does not have the option to view this printed ballot.

Software

The voting software was developed through a joint effort of technicians from the TSE and Microbase (a subcontractor for Unisys). The team performed several simulated elections and systems tests with the help of regional elections offices. These experiences helped in formulating the final version for the Production Model. The software for the voting systems remained proprietary, or “closed source.” The contracts with the suppliers allowed them to remain such under the premise of protecting intellectual property. Today, many are pushing for disclosure of the code [14] in order to enable third party auditing.

During the first round of elections technicians of the software group visited technical support points – assisting with software issues and gathering feedback. This process proved itself advantageous, for many issues surfaced that helped make the second round of elections much smoother. Due to the rigid fraud protection algorithms many simple errors by the operators were viewed as violations. This resulted in system lockups forcing the use of the backup “traditional” paper ballots. In the second round, the processes were streamlined, thus eliminating most false-positive fraud lockups.

The software for the voting machine is stored exclusively on the internal floppy disk. It can be broken down as follows:

- Operating System – The e-ballot uses the VirtuOS operating system, developed by Microbase. It supports a multi-task environment, which is critical for a smooth voting experience. In terms of voting, it allows voter identification in the Micro-terminal while other voters are filling in their ballots. Simultaneously, it allows power management, recording of event logs, printing of ballots and monitoring of the internal battery and sensors.
- Software Manager – Controls the OS, loads applications and drivers, and monitors sensors. Responsible for shutting down the applications at the end of voting.
- Application Software – Floppies are uniquely loaded with the appropriate applications for the tasks required of the e-ballot. Unique floppies are available for voting simulation, first and second rounds of actual voting, and for administration, maintenance and diagnostics.

LEAN: Development of Hardware and Software

To reduce **waste** – both in terms of investment and in terms of complex processes – Lean promotes the use of the simplest technologies that can get the job done. Jones and Womack [7] explain how Toyota refrained from introducing costly robotics and automation into their production plants, instead relying on the agility and skill of their line workers to complete complex tasks. The end result was higher quality and lower cost cars than those of their American competitors.

In the same way, Brazil's simple design of the voting machine is a comparatively minimalist product true to the spirit of Lean. The bare minimum required to conduct

streamlined voting was included in the system, and the design and technologies used were proven and robust. An economic and simplistic design allowed rapid production at large volumes, which answered the primary goal of the project – fast system-wide implementation.

The use of standard floppy disks was, at the time, an ingeniously simple and economical decision. With an internal hard-drive, skilled technicians are required to conduct system updates and disk replacements. With a floppy disk, these tasks can be completed by unskilled personnel or even poll workers when necessary. Today, flash memory chips could perform the same function.



Figure 3-7 – The VM User Interface

Screen-shot of the voting simulator developed by the TSE. Can be found on:

http://www.tse.gov.br/eleicoes/urna_eletronica/simulacao_votacao/UrnaApplet2.htm

3.2.6 Production and Quality Control

77,479 voting machine units were produced and distributed by Unisys over 120 days between June and September of 1996. To achieve this remarkable goal, the company anticipated a series of activities to ensure adherence to the delivery timeline. The following is a brief list of these activities:

- A company from Portugal was contracted for fabricating the molded casing of the VM.
- Parts suppliers were established in Brazil and abroad who could supply the necessary components in the appropriate time periods.
- The supply-chain was carefully laid out prior to inception of production. Transport of nationally produced parts as well as transport and customs -clearance of imported parts were pre-arranged. Such planning was vital to guaranteeing a perfect flow of VM assembly, testing and distribution.
- The logistics of purchasing and inventory management were carefully planned to ensure efficient production with sufficient time for quality control tests at the factory. High quality at the factory door meant less defects to resolve at polling locations or, worse still, forcing returns.

Assembly of the VM's was broken into 5 phases as follows:

1. Assembly of sub-assemblies – the front panel, the printing mechanism, the power supply, the CPU/motherboard and the back panel.
2. Joining of the sub-assemblies to a functional yet unfinished VM.
3. Concurrent testing and final assembly.
4. Integration of the Voter Unit and the Microterminal.
5. Final testing.

The production line was organized in a way that allowed monitoring of activities and their duration. Team sizes and composition were adjustable to meet the requirements of quality and schedule.

Final testing was conducted by technicians of both Unisys and the TSE and utilized the software that was to be used in the actual elections. Testing followed accepted international standards of quality control and included: visual inspection; functional tests – battery life, vibration, temperature cycles, safety, EM interference, and simulated abusive use. After their transport to the TRE's, which was done in rather adverse conditions at times, the VM's were tested again to verify their integrity before final distribution.

LEAN: Production and Quality Control

By carefully planning its production and quality control **value stream** ahead of time, Unisys managed to take a final model of the VM and fill its production and delivery quotas in a period of four months. The task was managed by lining up suppliers, arranging transportation of parts and dealing with red-tape in advance, allowing quick production ramp-up once the go-ahead was given. Using this careful coordination, Unisys managed to ensure process **flow** and timely delivery.

By building in sufficient flexibility in the assembly and testing lines, Unisys could adapt to unforeseen challenges inherent to producing a breakthrough product. Also, its choice to work in production teams afforded a better environment for engaging common difficulties encountered in the first production runs, as workers could rely on the combined set of skills in the team to solve problems. The Lean system recognizes these benefits and the flexibility they offer. Finally, by facing challenges together, members of teams are less likely to allow defects to go unnoticed. This allows for considerable savings – in less rework at the end of the line, in less field repairs and in less returned products. Less rework means less **waste**, less *muda*.

3.2.7 Deployment and Use

In May of 1996 an initial distribution of 400 voting machines was made to the regional elections offices. These units were copies of the initial Engineering Model, and their purpose was to familiarize the workers of the elections offices with the function of the VM. An additional 292 copies of the Qualification Model were sent out a month later and were used for final widespread evaluation and initial voter familiarization. The final delivery of the remaining 76,787 units was finished by September 9th, in preparation for the October 3rd elections (see Table 3-2).

The following is a timeline that describes the steps procedures of preparation, deployment and use of the voting machines in the period preceding the elections. Unlike the deployment described above, these procedures are repeated for every election with minor variations and updates.

Time Before Ballot Opening	Procedure
– 90 Days	5-digit numbers are assigned to each of the candidates and parties in the upcoming elections. Those that have appeared in previous elections usually retain the same numbers. First notices in the media appear, refreshing the public’s knowledge of voting procedures and guidelines.
– 70 Days	Four poll workers are chosen for each voting machine – the ballot president, 2 table workers and a secretary. They are notified by mail of their assignments. Assignments are mandatory (like US Jury Duty) and tend to last several years. Table workers / administrators are rotated in staggered form, to ensure adequate performance and passing of skills.
– 60 Days	A period of 5 days is allotted to political candidates and parties to inspect the software version that will be uploaded to the voting terminals for the election. The source code is not disclosed – the candidate’s representatives can merely experiment with finished

product, and no automated software can be used to facilitate this inspection.

– 20 Days	Free media slots are allotted to candidates and parties for use on public television and radio. Paid advertising timeline is unregulated.
– 10 to 20 Days	Meetings are conducted for the poll workers on dates mentioned in their initial mailings. Ballot presidents are given supplies for use on election day – copies of the regulations, poll worker certificates, passwords for the VM, meal vouchers, pens, etc.
– 14 Days	The general public receives notification of voting in the mail, informing the citizens of their poll locations and date and hours of poll operation.
– 7 Days	Regular notices in the media appear, describing in detail the function of the VM’s and the candidate’s numeric designators..
– 3 Days	All public advertising is ceased.
– 1-2 Days	The VM’s leave the central regional depositories and are taken to the polling locations. TRE representatives set up each VM in the presence of the ballot president assigned to it.
– 1-2 Hours	The overseer (president) of each VM receives a list of registered voters and an empty disk for recording the votes from the local representatives of the regional elections committees.
Voting Period	The line of those waiting to vote ends at the registration table. As each voter enters and displays their voter card, their name is found on the registry. The voter signs the registry (illiterates may use a thumbprint as signature) and at the same time the voter’s ID number is entered in the microterminal unit. The VM then becomes ‘unlocked’ and the voter may cast his or her vote.
Ballot Closure	The president of the ballot saves the data on an encrypted floppy disk and prints out 3 copies of the vote tally. The President delivers these materials to the city or regional elections office.
4 Hours After Ballot Closure	Normally over 99% of votes are counted and officially publicized by means of television and radio.

LEAN: Deployment and Use

The great benefit here is once again the use of a standardized procedure throughout the country. The **value stream** was centrally established and no time was **wasted** in each state and city on creating and testing separate procedures. This framework allowed quick adjustments to be made in the pursuing elections, as collective lessons learned could be easily implemented across the board. Also, the procedures were created by those that had the best vantage point for the system as a whole, and could appreciate what steps were most important for ensuring reliability and **flow**.

3.2.8 Public Education and Awareness

In anticipation of the 1996 elections, the TSE established a program to educate the voting public on the use of the voting machines. As early as March 1995, Minister Carlos Velloso, President of the TSE, started an initiative of informing the public about the digitization process of Brazilian elections. The focus of the campaign was on the security, reliability and, above all, the ease of use of the new voting system. This effort was divided into a national campaign as well as regional campaigns.

On a national level, ads were transmitted using television, radio, newspapers and periodicals. Also, various leaflets and brochures were distributed by the TSE, through the TRE's, to the general public. However, most of the work was in fact delegated to the regional elections offices so they could customize the content for the local population. Each of the 26 TRE's was granted autonomy in creating the publicity that best matched the culture, jargon and habits of the local population.

In addition, local campaigns reached to colleges, universities, workplaces and public gathering areas. Model VM's were set up in supermarkets, churches, sports arenas and even circulated on vehicles that visited public markets and plazas to give citizens a chance to experiment with the technology on a first-hand basis. The public edification

program was considered a success, as evidenced by the low occurrence of long lines at the polls, despite a turnout of over 80%.

LEAN: Public Education and Awareness

This final element of preparation reflects the importance of extending the **value stream** all the way through to the consumer. If the end user is not as well informed as the other stakeholders about the product and its use, much of the purpose is lost. The Lean system strives to include the end user as part of its complete **value stream**. This inclusion ensures the process is always oriented towards the correct goals and is always handed off responsibly to the next participant.

In the U.S. we often encounter difficulties arising from weak handoffs – or what Lean describes as interruptions in **value stream flow**. This is especially apparent when modern complex voting machines are delivered to polling locations lacking adept manpower. The result is unsatisfactory performance of polls on elections-day and poor voter experience. This could be solved, in part, with well planned processes like those described above.

3.3 Feedback, Lessons Learned and Further Development

Table 3-4 reviews the progression of voting machine deployment in Brazil from 1996 through 2000 (further updates appear at [15]):

Election Year	1996	1998	2000
VM Model	UE-96	UE-98	UE-2000
Voting Electronically	32.5 Million	61.1 Million	109.8 Million
% Voting Electronically	32.07%	57.62%	100%
Locations	Cities with pop. Over 200,000	Cities with pop. Over 45,000	Countrywide
Counties	57	537	5,559
No. of Machines	77,469	152,370	353,875
Battery Life	3 hours	4.5 hours	13 hours
Redundant Storage	Printer	Flash Memory	Flash Memory
Hardware Failure in %	3.65% *	0.70%	0.02%
Platform	386SX 40MHz, 2MB RAM	586 100MHz, 8MB RAM	586 150MHz, 32MB RAM
Storage Capacity	Floppy 1.44MB	Floppy 1.44MB + Flash 8MB	Floppy 1.44MB + Flash 16MB
Cost w/Service	US\$ 1,000	US\$ 750	US\$575

Table 3-4 – Cumulative Voting Machine Data (Brazil)
Data for 1996 through 2000 election years

- * – Breakdown: 0.92% due to hardware problems, 0.88% due to software problems, 1.76% due to misuse (by officials or voters) and 0.09% due to unidentified causes. In the second round in 1996, total failures were already reduced to less than 1.44%, proof of an efficient response to the problems.

The machines show a steady improvement from elections to elections, while the cost of their production falls. Most of this progress was enabled through leaps in available technology – such as longer battery life and the use of flash memory for backup. The reduction in failure rates and cost can be attributed in part to better technology, but the learning-through-doing process must have helped improve these metrics as well.

3.3.1 Issues with System Security

Brazil [has] implemented electronic voting in all steps [of the voting process]. However, this does not mean that Brazil is leading in this technology but instead that it crossed the state-of-the-art boundary in an imprudent and unsafe manner.

Amílcar Brunazo Filho [16]

The issues of voting security are probably the most criticized aspect of the system deployed in Brazil. One in three [see Appendix A] eligible voters interviewed mentioned they had heard criticism of the systems in the media, and the public perception of overall system security suffered in comparison to VM ease of use, precision and trustworthiness over paper voting. In academic and political circles, this questioning is much fiercer. Skepticism is based on the vulnerabilities of electronic media and software to fraud and sabotage, and on weaknesses that might allow ballot stuffing and incursions on privacy.

Dr. Amílcar Brunazo Filho maintains a website (<http://www.votoseguro.org>) with articles and reports of security issues with Brazil's electronic voting machines. Some of the vulnerabilities he had quoted pertain to software code susceptibility to insider and outsider attacks. Others [14] relate to the possibility of ballot stuffing by poll workers who may use ID numbers of no-shows and cast ballots in their place. Brazil's ability to answer these concerns over time will be the ultimate test of its long-term commitment to effective processes and **continuous improvement**.

3.3.2 Outstanding Issues and Problems

Other issues relating to the voting technology and election administration can be noted as problematic in the existing system. One example is in the user interface – voters must read the name of their selected official and enter the corresponding number using the keypad. Only then does a picture of the candidate appear. Illiterate voters, therefore, must either memorize their official’s number or use trial and error to get the right picture to appear. On the issue of privacy – at the end of the elections the poll workers print out a tally of votes. These are printed in the same order as they were cast. It is possible, therefore, to figure out voters’ choices by merely following the order of voters entering the ballot.

LEAN: Outstanding Issues and Problems

In conclusion, while the original Brazilian system was well executed and deployed, it is by no means perfect. The tight development and production schedules left limited time for field testing. As a result, the use of the voting machines in actual elections served for their first large-scale testing. It is crucial that the feedback generated from these experiences be used to improve on the current platform and procedures.

Brazil’s ability to use its experience and the opinions of professional and academicians to further **pursue perfection** in its voting system will help it sustain its current success and public support.

Chapter 4

Elaborating the Lean Election Model for the U.S.

4.1 Methods of Applying Lean

By now the reader should be able to appreciate the potential benefits of applying Lean principles to the US elections system. Part I presented the problems facing the US in terms of election technology and administration. Part II discussed the basics of the Lean model and proposed how it can relate to voting and aid in facing its challenges. Part III showed how the Brazilian elections benefited from a management that, while not intentionally conducted according to Lean, is quite reminiscent of it.

The breadth of the voting system in the US is tremendous and its complexity is high. It offers an environment remarkably different from Brazil in the 1990's (see Table 4-1). The disparaged structure in the US stands in stark contrast to Brazil's centralized control of all election activities. A centralized structure makes it easier to apply management initiatives such as Lean to technology, poll administration, finances, etc.

	Factor	Brazil circa-1995	US circa-2005
Policy	Ballot Definition	Centrally by professionals	Local elected officials
	Auditing and Certification	Central	No standards, varies by jurisdiction
	Close Elections	Runoff	No standards, varies by jurisdiction
	Poll Staff Recruiting	Mandatory Civil Service	New hiring process each election
	Voter Registration and Update	Automatic, national system	No standards, varies by jurisdiction
Technology	Voting Machine Development	Jointly by the TSE, Academics and Suppliers	Proprietary, undisclosed and unmonitored
	Software Upgrades	Vendor, TSE Authorized	No standards
	Power Interruption Contingency	13 Hour battery life	No more than 4 hours
	Ballot and Machine Testing	Software assisted	No standards, varies by jurisdiction
Deployment and Polling	Storage and Transportation	TSE and TRE Coordinated	No standards, varies by jurisdiction
	Deployment	Regionally regulated and monitored	Controlled by local voting jurisdiction
	Poll Staff Service Period	Staggered to train new recruits, normally 4+ years	Favors people with no other commitments
	Polling Place Procedures	Nationally uniform, explicit	Varies by city, county and state, ad-hoc
	Poll-Watching	Party representatives	No standards, varies by jurisdiction

Table 4-1 – Differentiating Factors (Brazil vs. US)
Brazil vs. US Environments at Time of Voting Technology Implementation

The Lean Enterprise Model (LEM) [17] proposed by the MIT Lean Aerospace Initiative was briefly mentioned in Chapter 1. A detailed copy of it can be found in Appendix B. It presents a breakdown of all the important elements of Lean and the order by which they should be implemented. Also, the following roadmap (Figure 4-1) was published by LAI. It concisely follows the steps of applying Lean in practice, starting with making the commitment, analyzing the value stream, suggesting changes and implementing them. The cycle is then repeated, as the improved value stream is reevaluated and new changes suggested.

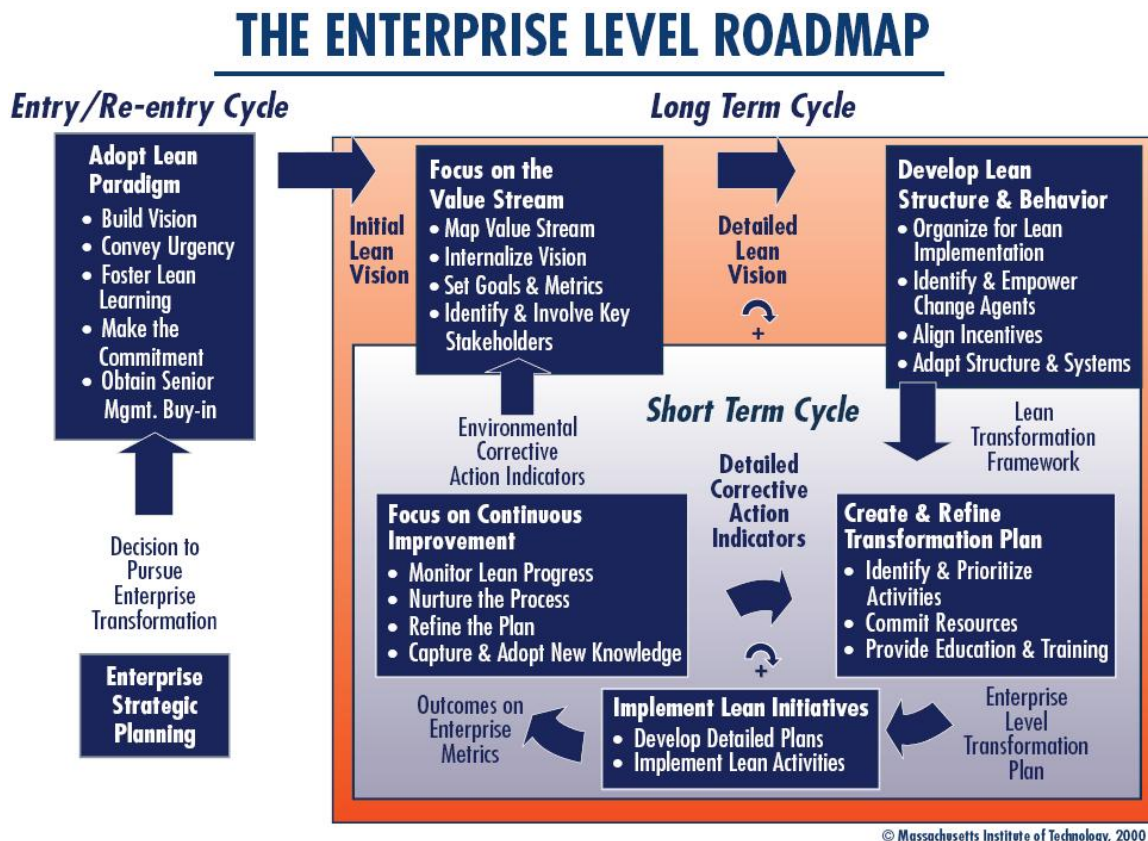

Figure 4-1 – Roadmap to Lean
Roadmap for implementing enterprise Lean Transformation
Published by LAI [18]

4.2 Applying Lean to US Voting Administration – Divide and Conquer

As proposed by the Lean Roadmap (Figure 4-1), we will focus initially on the entry phase. This stage is marked by committing to organizational change and senior management buy-in. Next, we will focus on the value-stream of each of the voting system's major components. To this end, we identify Voting Technology, Poll Management and Public Relations and Interface. While this division is somewhat arbitrary, it is necessary when dealing with such a complex process. Nevertheless, all these subsystems are tightly interdependent, and a Lean Transformation has to occur across the board to be most effective.

4.2.1 Committing to Lean

Lean Transformation starts with a commitment at the top. Senior management must take the initiative of making it an organizational priority. It must do so to set an example and lead the effort of change, and later to guarantee changes are sustained over time. For this purpose, the objectives of Lean must be incorporated in objectives of the company. Ensuring value creation, flow, pull and waste reduction on the way to achieving perfection should be incentivized and engrained in the company culture.

Voting legislature and policies play the role of senior management in the U.S. election system. It is therefore paramount that the Lean effort be embraced by policy makers. This does not imply a demand to change voting laws which have been extensively debated and found complimentary to US democracy. Rather, it calls for utilizing Lean as a way to ensure these laws and policies are better implemented. In fact, as Lean practices start bringing improvement, policies which impede positive change will be easier to identify and revise.

To summarize, policy makers, elections officials as well as industry and academic leaders must jointly make the initial step of ideologically backing the process.

4.2.2 The Technology Value Stream

Lean can be applied to the voting technology value-stream on two levels. First, the development, production and deployment of the voting machines can be made more efficient and cost effective. This improvement in the value-stream of the physical product will be treated only briefly below, for many examples for such processes exist in other industries. Second, the implementation of innovative enabling technologies can have a crucial part in the system-wide application of Lean. These revolve around improving voter performance and increasing transparency of voting technologies. These have direct affect on improving process flow and reliability.

4.2.2.1 Improving the Product Value-Stream

Let us first focus on applying Lean to the product value-stream. In the past decade, the development and production of voting machines has been conducted by several companies with varying degrees of collaboration with government and academic institutions. This has brought forth a wide selection of voting machines with diverse user interfaces, operational procedures, security measures, recording mechanisms and voter-verifiable elements. This process has proved itself both beneficial and problematic.

On the one hand, a wide selection of solutions allows for productive experimentation, amassing experience that helps in improving and optimizing the characteristics listed above. At the same time, a diverse set of solutions makes it difficult to control their reliability and security features. The rapidly changing technologies make it harder to train poll workers who might be under-skilled and unfamiliar with advanced technologies. Finally, the performance data, operational systems and hardware all remain proprietary, impeding true synergetic advances in the field.

To this point, this process has been somewhat tolerable, under the premise of developing nascent and innovative technologies. However, as voting technologies are being widely

implemented in the U.S., better oversight would be beneficial to ensure a more standardized product – and not only in terms of reliability and security – but also in terms of usability and accessibility. As shown by Brazil’s ATM-like numeric keypad, good user interfaces have better longevity over time and are more likely to leave voters with a positive impression.

While academic groups and manufacturers are still developing better solutions for the future, voting machines are being manufactured and deployed across the nation to an extent that over 29% of votes in the 2004 elections were already cast electronically [19]. As the diversity of voting solutions increases, so will the difficulty of training poll workers and the general public on their effective use. Widespread problems have already been well documented by Selker [9]. While future development should be continued and encouraged, better control should be implemented for machines that are currently being mass produced and distributed.

To avoid future problems in use and deployment, in accordance with a Lean approach, exchange of information between government and academic institutions and voting machine developers should be facilitated and encouraged. Products should be more standardized and centrally controlled. The EAC (Election Assistance Commission) has published lists of standards for voting machines in the Help America Vote Act of 2002, and another is due by the end of 2005. However, such standards do not lead to standardization – as the deployment, operation and the user interfaces of the systems remain unique. This precludes both the voters and the poll workers from becoming comfortable with a familiar system and interface.

In the context of technology advances, below is an analysis of several technologies under investigation at the CalTech-MIT Voting Technology Project. They contribute to Lean Transformation in different ways. The first creates a solution that answers the customer's needs, or pull, by allowing multi-modal feedback of voter input. Since recording the voter's choices is our ultimate goal, their easy and accurate registration is critical to proper democratic process and voter experience. The second utilizes open-source programming and redundancy to increase transparency and reliability of the voting process. This would enhance the confidence all stakeholders have in the system which is crucial to continued Lean Transformation.

4.2.2.2 Low Error Voter Interfaces and Verified Voter Trails

In manufacturing applications, Lean techniques have simultaneously helped raise productivity and improve production quality. This is opposed to prior norms, where jacking up production usually caused quality to suffer. Achieving both productivity and quality have been enabled by focusing on the human factors of production. Factory floor layouts were redesigned to facilitate production activities and reduce unnecessary movement of materials. Low-level line workers were empowered to comment on quality problems as they appeared on the line, as opposed to waiting for quality control specialists or even customers to find product flaws. This meant getting things done right the first time, resulting in less rework and less warranty claims.

This approach for attaining high throughput and reliability is a focus of a research effort conducted by members of the Caltech/MIT Voting Technology Project. Selker et al [20] have created a user interface called *Low Error Voting Interface* or LEVI. The interface gives better structure to the voting process and has been proven to reduce the error-rate of voters by almost 50% in comparison with commercial systems (like Sequoia and Deibold). While usage times for LEVI have not been shown to be shorter than those of commercial systems, the lower error rate suggests that future versions of LEVI will allow voters to reduce the time spent on checking errors and shorten the overall time of voting.

In addition to the benefits described above, users were shown to consistently prefer the LEVI interface to commercial alternatives. The LEVI interface was reported to be less disorienting and more intuitive than the alternatives. The study confirmed that with an appropriate interface, users can feel more secure in their voting. This sense of security, and a generally more positive user experience are testimony of a product that meets the needs of its users. The technology value-stream would best be realigned to such measures that consider customer pull.

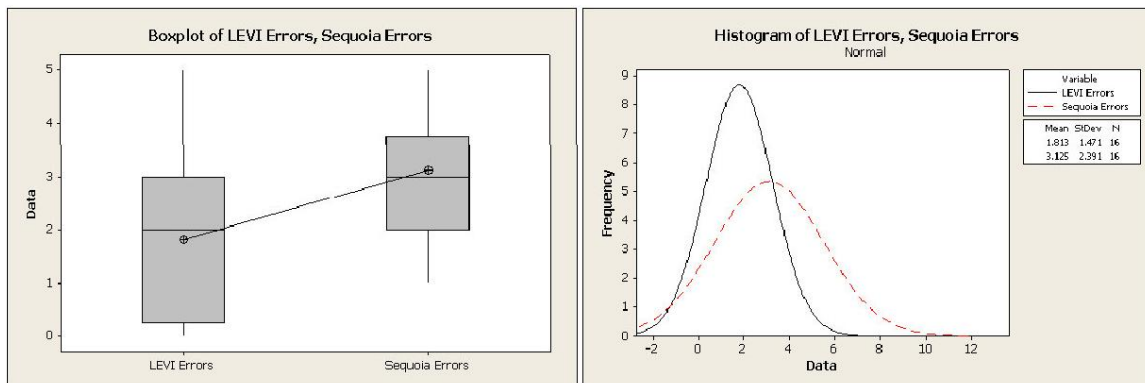

Figure 4-2 – LEVI vs. Sequoia Errors

Both average number of voter errors and median number of voter errors is reduced with the Low Error Voting Interface.

4.2.2.3 Secure Architecture for Voting Electronically

To help with Lean Transformation, organizations often try to increase the **transparency** of their processes. The idea is to help all stakeholders better understand the current state of the system, their responsibilities in the system and the immediate and long-term goals of the system. This helps empower individuals at all levels to recognize problems and find ways to solve them at the source. On the production floor, this transparency often takes the form of charts and electronic bulletin boards updated in real time. These may highlight production bottlenecks, display current vs. target production levels, note workplace injury rates and give general performance data about the company.

The idea of sharing and opening information to all those involved in a process has several desirable effects. As mentioned above, it helps empower individuals to recognize and solve problems. It also increases their sense of involvement and trust. Equivalently, the more transparent the voting system, the higher its credibility. With this credibility come higher public participation rates and more positive views on voting. These, for example, help secure better funding and attract more qualified personnel to work at polling locations.

Staunch criticism of security flaws pertaining to electronic voting machines has been raised by various groups. Kohno et al [21] found that Diebold's AccuVote-TS 4.3.1 widely used system is far below even the most minimal security standards applicable in other contexts. They identified incorrect use of cryptography, vulnerabilities to network threats, and poor software development processes. Vulnerabilities were proven both to outsiders and to insiders, the second of which (such as poll workers) could modify votes, violate voter privacy and match votes with the voters who cast them. They concluded that Diebold's voting system is unsuitable for use in a general election.

The authors suggested that the best solutions are voting systems that have voter-verifiable audit trails and those that use an open process of development. Their assumption is that as more scientists, software engineers, political activists, and others who value their democracy pay attention to the quality of the software that is used for their elections, the lower the susceptibility. For this reason, Australia is currently using an open source voting system [22]. An attempt to structure a system in the US that answers the need for a transparent yet secure voting system is being conducted at the Caltech/MIT VTP.

Prof. Ted Selker and Jonathan Goler of MIT [23] have introduced the concept of **SAVE** – **Secure Architecture for Voting Electronically**. **SAVE** offers architecture based on redundancy at each stage of the ballot submission process that is resistant to external hacking and internal insertion of malicious code. From the moment voters submit their votes, a redundant audit trail keeps track of all votes, rendering a physical paper trail unnecessary. Verification of eligibility, authentication and aggregation of votes are

conducted independently and can be processed in parallel by multiple systems. Each system arrives at the results on its own, offering an overall system that is extremely robust with low susceptibility to hacking. In fact, adding additional electronic redundancy is so cheap and easy, that susceptibility can be practically brought to zero.

Systems such as SAVE often rely on a continuous connection of the voting machines to the national system. This connectivity, whether wired or wireless, allows additional measures that ensure the overall security of the system. A few examples of this are:

- Constant connectivity allows the simplification of hardware and software of the individual voting machines. They can simply act as UI (user-interface) modules, much the same way thin-clients are used in centralized metaframe computer systems.
- Linking the units to a national network allows keeping the database of voters in a central and secure location. This helps prevent fraud, facilitates updates and gives greater flexibility to voters in choosing their voting location.
- The transmission of votes over more than one encrypted communication link offers a redundant reporting mechanism. This reduces the cost and complexity associated with physical voting records (be it CD-ROM, paper, flash memory, etc.)

Creating redundancy throughout the system is relatively inexpensive, except when it comes to the user interface. Every additional system that is required to record the vote at the moment the voter places it necessitates additional hardware, complicates installation and increases costs significantly. The CERTI foundation in Brazil [24] has developed a solution for their voting machines that allows an additional level of redundancy, and they suggest its use on a random sample of VM at each election.

Nevertheless, systems such as SAVE not only increase security, reliability and transparency, but help in achieving better process efficiency and *flow*. As electronic vote

collection and aggregation processes are made more secure, the problematic human handling of these tasks can be reduced.

4.2.3 Lean Applications to the Poll Management Value Stream

While poll management comes up third in our review it is perhaps the most important in terms of the opportunity it offers for applying Lean. Since Lean was originally intended for improving labor intensive manufacturing processes, it focuses on creating an organized, ergonomic, and adaptive working environment. On the production line, this means a smart layout of machinery and parts which reduces the physical and mental stress of workers. It also helps reduce the *takt time*.

Takt time is defined [25] as the available production time divided by customer demand. For example, if a part factory operates 10 hours per day and customer demand is 300 parts per day, the takt time is two minutes. The purpose of takt time is to precisely match production with demand. It provides the heartbeat of a Lean production system. Takt time was first used as a production management tool in the German aircraft industry in the 1930's. It was the interval at which aircraft were moved to the next production station on the line. The concept has been widely utilized within Toyota since the 1950's. Toyota engineers typically review the takt time for a process every month, with a tweaking review every ten days.

While reducing the amount of time necessary to process each voter is a gallant effort, it is not as critical as reducing cycle time in commercial situations. Much more critical issues currently exist in poll location management with which Lean could help. Alvarez [5] analyzed election administration problems at poll locations using the principal-agent theory, and found that the best solution is to embrace polling methods that avoid the poll-location altogether. Specifically, vote-by-mail, early voting and internet voting are discussed. While these offer ways to avoid the problems at polling locations altogether, they each present significant drawbacks which account for their low adoption to date.

As conventional polling locations continue to dominate, I will review a set of issues that plague them as reported by Prof. Ted Selker [6] in “How to Improve Polling Place Procedures.” Again, Lean will be shown to compliment efforts to resolve these issues:

Many common polling-place problems occur because election officials and poll workers are required to perform ‘unnatural’ actions that run counter to basic social protocols and decorum. If we reorganize procedures to respect and reinforce social commitments, instead of forcing people to override deeply ingrained impulses, then we may greatly reduce such errors. Examples of creating socially supportive ways of double checking counts, cross-checking records, handling and transporting voting material mechanisms can be designed to catch and correct mistakes as they happen. Like all social encounters, such organizational improvements require thoughtful design and planning and practice but little capital investment. They offer a tangible means through which the integrity of election results can be more secure, regardless of the type of voting system or verifiable audit trail in use.

Ted Selker [6]

As a first step, let us take a look at a proposed value stream that describes the process. The value stream pertaining to the phases of deployment through vote counting is shown in Figure 4-3.

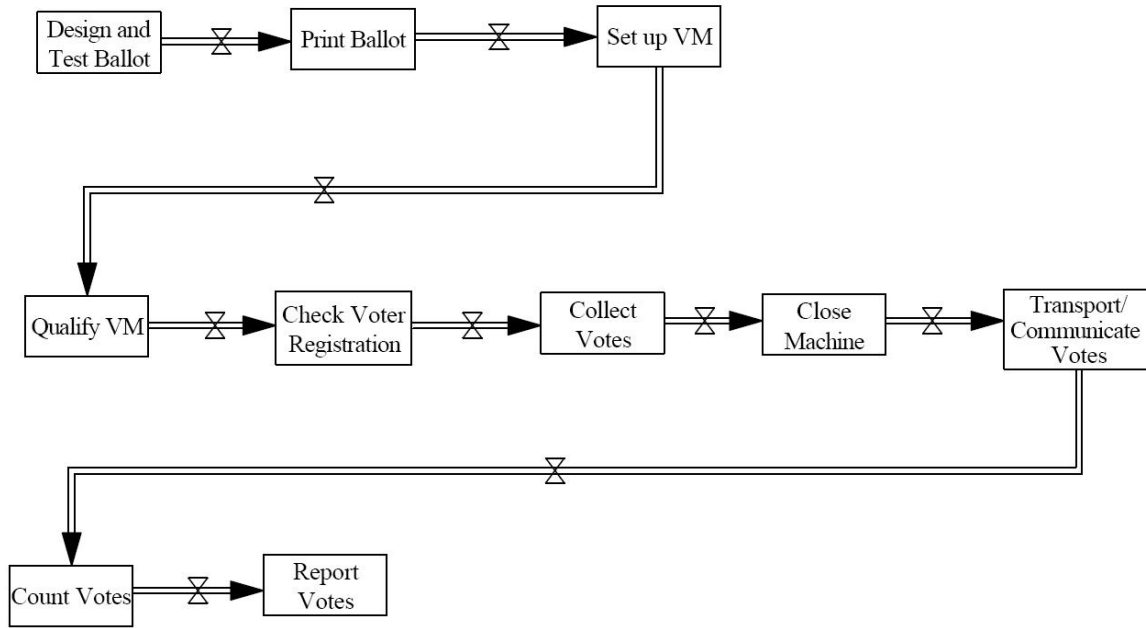

Figure 4-3 – The Voting Deployment Value Stream

Each row covers a separate phase of voting deployment:

Before Poll Opening, During Poll Operation and After Poll Closure

The following are issues that impede a reliable flow of the voting process, each with a brief example from Selker’s report:

Misguided Policies

Due to a lack of holistic view of the system, administrators occasionally create policies that undermine election security. He gives an example of a policy that mandates transport of three redundant vote registries (the paper ballots themselves, the ballot-reading machine with a record of the aggregated votes and the ballot memory module) by a single police officer. Transporting all three together by default undermines their redundancy.

Lack of Policies

Lack of policies can create just as much potential harm as misguided ones. Selker gives an example of an election administrator that did not create physical backups of election results simply because such a procedure was never defined. Also, since the current poll

administration system is not well structured to document, analyze and react on past problems, poll workers end up inventing their own corrective procedures. These measures often lack the vision of vote security and privacy. An example of this is the ad-hoc fixes poll workers attempted for paper jams in paper-trail printers in various locations in the 2002 and 2004 elections.

Policies that Are Counterintuitive to Poll Workers

Some policies appear counterintuitive to poll workers and end up being abandoned or altered. For example, when initializing and closing down voting machines two poll workers are often required to independently record odometer readings and serial numbers for each of the machines. In reality this ends up being done by a single person, or with one person reading out the numbers and the other recording them. This adjusted technique undermines the verification intended in the redundant recordings.

Lean affords a structure to address these issues. The ideas below are reminiscent of techniques one might find on a Toyota manufacturing floor:

Use of Standard Physical Reminders

Selker suggests implementing a system of physical reminders for poll workers. This is reminiscent of the Lean *Kanban* – standard placards or objects used to cue processes. Examples include the use of different colored pens and double-columned forms for redundant annotations, stickers for labeling and marking completed tasks, and tamperproof seals for voting materials. Even the use of traditional curtains surrounding the voting areas is noted as a “reminder to all” of the voter’s right to privacy.

Encouraging ‘Team Spirit’

Selker stresses that it is especially important that poll location policies encourage teamwork and mutual responsibility so that election materials are handled in a secure and organized manner. Lean encourages the use of teamwork to reduce errors and increase reliability and quality. While in an industry environment constant monitoring of quality

saves significant costs down the line, in the voting environment it is vital for ensuring every vote counts.

Keeping Stakeholders Informed and Motivated

The *Andon* board is a useful tool for process management and monitoring that emerged from Toyota's assembly plants. The word *Andon* in Japanese stands for a lantern, a signaling device, or even a commercial sign. In manufacturing facilities it is an electronic audio and/or color-coded visual display. It is used to inform workers of the quality of their work and of their productivity. Figure 4-4 shows examples of two *Andon* boards used on production floors, and a proposed unit for polling locations. While these are simple examples, indicators can be incorporated for machine status, electronic checklists, warnings of missed procedures, etc. The effect is of keeping participants informed and motivated about the process.

Process Standardization

The overarching principle that comes forth from reviewing and comparing the voting systems in the US and Brazil is the importance of standardization. It should be applied both to polling technology and to poll management. Regarding technology, not only should a standardized voter user interface be sought, but also a standardized administrator user interface. As many weaknesses in security and reliability are generated by poll workers unfamiliar with rapidly developing technologies, this should have the effect of reducing confusion and mistakes.

Standardizing the poll management timeline and procedures should be done by professionals with good vision of the entire system and its goals. In that manner, the policy issues raised above can be avoided. The most beneficial effect of process standardization, already proven for some time on production floors, is that it allows quick adjustments to be made once a problem is encountered. Since the entire organization follows a single process, a single fix is all that's necessary. Similarly, collective lessons learned could be easily implemented across the board from election to election.

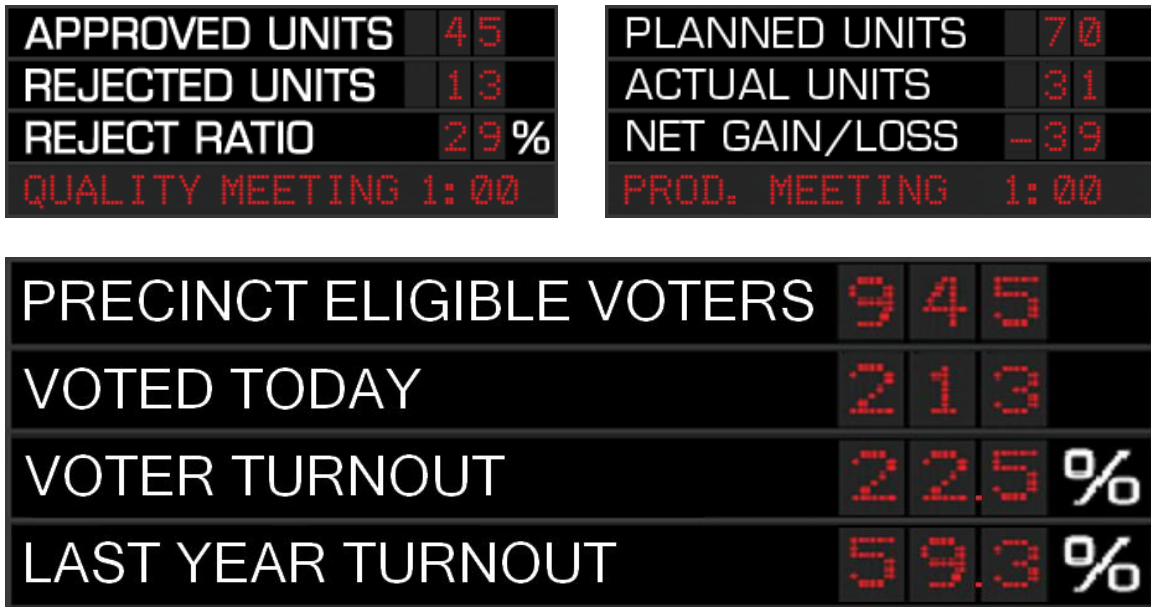

Figure 4-4 – Andon Boards

Boards like the top two are often used on Lean production floors
(left – quality, right – productivity)

The bottom board is a proposed Andon for polling locations

4.2.4 The Public Relations and Interface Value Stream

Public exposure to the voting process is mostly limited to the poll location, the voting machines and the final distribution of results. To a certain extent, media advertisements, mailed voter cards and prospectuses help shape general public opinion, but experiences in the immediate temporal proximity to the voting time are most crucial. Therefore, we can assume that positive results for efforts in the technology and poll management alone are likely to substantially improve the public perception of the voting process.

Nevertheless, there is much to be said in the benefit of a carefully planned public interface for releasing election results. Currently, in their attempt to please the viewing public, network news channels try to release results as quickly as possible, even if these are unqualified. The 2000 Presidential Elections had proven the extreme confusion and public distrust that can emerge from such weaknesses. While the actual flaws in the

election procedures were primarily to blame, the lack of an organized response of the election administration to the situation helped in creating a genuine fiasco.

The first step in avoiding a repetition of such events is to analyze the value stream of the existing process and streamline it as to avoid periods of public uncertainty and confusion. Next, the major active stakeholders in the process, the election administration and the media outlets, should be better integrated into the value stream to ensure a good flow of correct information. Once this is ensured, the needs of the public for up-to-date election results (read: the pull of the customers for a timely and quality product) can be guaranteed.

4.3 Continuous Improvement and Six-Sigma

The Lean improvement process is, in essence, an iterative cycle. The goal is to continually improve the performance of the organization by applying the measures covered above. In fact, this final step merely brings us back to the beginning, just as shown in the Roadmap to Lean (Fig. 4-1). After initial steps are taken to improve technology and its deployment, poll management and the public interface of election systems, the results must be evaluated and new suggestions made. This cycle continues indefinitely.

Most process improvement techniques are quickly abandoned after their initial adoption. In some cases, they lack the proper backing and commitment to be fully implemented – resulting in failure. In others, after some improvement is achieved, motivation for change decreases and progress staggers. Lean acknowledges this natural tendency to fall off in performance. To overcome, it calls for constant pursuit of perfection and continuous improvement. In fact, as long as every stakeholder remains committed to improvement, it will happen, both by way of the steps covered above and through the use of common sense.

After Lean helps in restructuring the way organizations face their challenges, it becomes easier to apply other process improvement techniques. Six Sigma often stands out as a counterpart to Lean Transformation. Six Sigma is a metric based methodology that uses data and statistical analysis to measure and improve a company's operational performance. By identifying and eliminating "defects" in manufacturing and service-related processes, it acts as a good quantitative counterpart to Lean's pursuit of perfection.

The name Six Sigma comes from the field of statistics, where 6σ quality is defined as 3.4 defects per million parts. The technique often applied is called DMAIC, which stands for Define, Measure, Analyze, Improve and Control:

- Define – What problem needs to be solved?
- Measure – What is the capability of the process?
- Analyze – When and where do defects occur?
- Improve – How can process capability be Six Sigma? What are the vital factors?
- Control – What control can be put in place to sustain the gain?

Additional information on Six Sigma can be found in various books and articles, as well on <http://www.isixsigma.com/>, a site dedicated to the Six Sigma community.

(this page intentionally left blank.)

Chapter 5

Conclusions

In this report, we pursued a systematic exploration of a new methodology to help ameliorate some troubling aspects of voting administration in the US. Starting with a general problem definition, we then proposed the Lean Model as a method of realigning the disparaged efforts which, in their current form, are lacking the synergetic effect of a structured approach. We then showed how Lean has proven itself, albeit unpremeditated, in the highly successful Brazilian system.

Finally, we pursued a methodological evaluation of each major component of the US voting administration to seek ways of enabling change. The major components identified were Legislation and Policies, Voting Technology, Poll Management and Public Relations and Interface. In each, elements Lean Enterprise Model were applied to the problematic issues. The Roadmap to Lean was used as a guide for the steps necessary to initiate change in the current system.

Improving the way US voting is administered through better structure, communication and feedback among stakeholders is a crucial first step in improving its reliability, accessibility and security. After these changes are in place, further efforts can focus on applying techniques such as Six Sigma to further address problems in quality control and reliability.

What is reported here is just an initial proposal, a marketing of sorts for Lean Voting. In reality, each stakeholder knows its needs best, and the Lean Model merely calls for improved communication of these needs. The belief is that by synergies of the stakeholders working together the system benefits and, in turn, rewards the stakeholders.

The authors hope to induce feedback about this model from the Lean and voting communities to help with its further elaboration and perhaps even implementation.

REFERENCES

- [1] BBC News, *Postal Vote Increases Turnout*, Published: 05/012003
<http://news.bbc.co.uk/go/pr/fr/-/1/hi/england/nottinghamshire/2993145.stm>
- [2] Thomas W. Lauer, T.W., *The Risk of e-Voting*, Electronic Journal of e-Government, Vol. 2, Issue 3., Sept. 2004
- [3] Alvarez, M.R., *American Elections: A Critical Moment for Research and Reform*, Caltech/MIT Voting Technology Project, Pasadena, CA 2004.
- [4] Hall, T.E., Alvarez, R.M.. *American Attitudes about Electronic Voting – Results of A National Survey*, Center for Public Policy & Administration, University of Utah, 2004.
- [5] Alvarez, M.R., Hall, T.E., *Why Everything That Can Go Wrong Often Does: An Analysis of Election Administration Problems*; Caltech/MIT Voting Technology Project, Pasadena, CA 2003.
- [6] Selker, T., Young, C., *How To Improve Polling Place Procedures*, Caltech/MIT Voting Technology Project, Boston, MA 2005.
- [7] Womack, J., Jones, D., Roos, D., *The Machine that Changed the World*, Scribner 1990.
- [8] Spear, S., Bowen, H., *Decoding the DNA of the Toyota Production System*, Harvard Business Review, September-October 1999.
- [9] Selker, T., *Processes Can Improve Electronic Voting: A Case Study of an Election*, Caltech/MIT Voting Technology Project, Boston, MA 2004.

- [10] <http://www.electionguide.org/turnout2002.htm>
- [11] Unknown, *Brazil - Government and Politics*, The Country Studies Program (formerly the Army Area Handbook Program) http://www.mongabay.com/reference/country_studies/brazil/GOVERNMENT.html
- [12] *Urna Eletrônica*, Electronic Ballot; <http://www2.samurai.com.br/urnaeletronica/>
- [13] Camarão, Paulo César Bhering; *O Voto Informatizado: Legitimidade Democrática*; São Paulo: Empresa das Artes, 1997.
- [14] Filho, Amílcar Brunazo., *Burla Eletrônica*, Fundação Alberto Pasqualini, Rio de Janeiro, Brazil. 2002.
- [15] *Estatísticas da Urna Eletrônica*, Statistics of the Electronic Ballot; <http://www2.samurai.com.br/urnaeletronica/estatisticas>
- [16] Filho, Amílcar Brunazo., *A Segurança Do Voto Na Urna Electronica Brasileira*, TD Tecnologia Digital Ltda., São Paulo, Brazil. 1999.
- [17] *Lean Enterprise Model*, Lean Aerospace Initiative, MIT, Cambridge, MA 1996, http://Lean.mit.edu/index.php?option=com_docman&task=doc_download&gid=70
- [18] *Roadmap to Lean*; Lean Aerospace Initiative, MIT, Cambridge, MA 1999, <http://Lean.mit.edu/index.php?task=view&id=53&Itemid=63>
- [19] *Voting Equipment Summary By Type as of 11/02/2004*, Election Data Services Inc, Washington, DC. http://www.electiondataservices.com/VotingSummary2004_20040805.pdf

- [20] Selker, X.X., Goler, J.X., *Orienting Graphical User Interfaces Reduce Errors: The Low Error Voting Interface*. MIT Media Lab, Boston, MA 200X.
- [21] Kohno, T., Stubblefield, A., Rubin, A.D., Wallach, D.S., *Analysis of an Electronic Voting System*, IEEE Symposium on Security and Privacy 2004, IEEE Computer Society Press, May 2004.
- [22] <http://www.elections.act.gov.au/EVACS.html#code>
- [23] Selker, X.X., Goler, J.X., *The SAVE System: Secure Architecture for Voting Electronically. Existing Technology, with Built-in Redundancy, Enables Reliability*. MIT Media Lab, Boston, MA 200X.
- [24] Guimarães, M.F., Sell, C.A., Turcato, R.P., Assuiti, C.H., Custódio, R.F., Santos, R.A.P., *Proposta de um Sistema Eletrônico de Auditoria Aplicado à Urna Eletrônica Brasileira*. CERTI Foundation, Florianópolis, SC, Brazil. 2001.
- [25] Marchwinski, C., Shook, J., *Lean Lexicon*, Lean Enterprise Institute, February 2003.
- [26] Alvarez, M.R., Hall, T.E., *Lessons and Trends in E-Voting: Initiatives in the US and Abroad*. Caltech/MIT Voting Technology Project, Pasadena, CA 2005.

APPENDIX A – BRAZIL VOTING SURVEY

The following survey was distributed in the cities of Porto Alegre, Cavahada and Teotonia in the state of Rio Grande do Sul, Brazil during August 2005. Respondents were chosen from different age groups and various income and education levels.

A separate study will be published in the near future with a full review of survey results.

(continued on the next page.)

Voting Survey

1) Age? _____

2) Have you ever voted on paper...

a) before the introduction of the electronic voting machine? Yes No

b) due to a problem in the electronic voting machine Yes No

Rate the following statements: **1** – I Strongly Agree, **4** – Neutral, **7** – I Strongly Disagree.

3) Electronic voting machines are easy to use.

Strongly Agree			Neutral	Strongly Disagree		
1	2	3	4	5	6	7

4) Electronic voting machines are accurate.

Strongly Agree			Neutral	Strongly Disagree		
1	2	3	4	5	6	7

5) Electronic voting is more trustworthy than paper voting.

Strongly Agree			Neutral	Strongly Disagree		
1	2	3	4	5	6	7

6) I prefer electronic voting in comparison to paper voting

Strongly Agree			Neutral	Strongly Disagree		
1	2	3	4	5	6	7

7) The companies that produce the electronic voting machines are trustworthy

Strongly Agree			Neutral	Strongly Disagree		
1	2	3	4	5	6	7

8) Having the electronic machines print the individual ballots would make them more trustworthy.

Strongly Agree			Neutral	Strongly Disagree		
1	2	3	4	5	6	7

9) It is possible for someone to manipulate votes cast electronically.

Strongly Agree			Neutral	Strongly Disagree		
1	2	3	4	5	6	7

10) A paper vote is less likely to be lost than an electronic vote.

Strongly Agree			Neutral	Strongly Disagree		
1	2	3	4	5	6	7

Statistical Analysis of Voting Survey Results

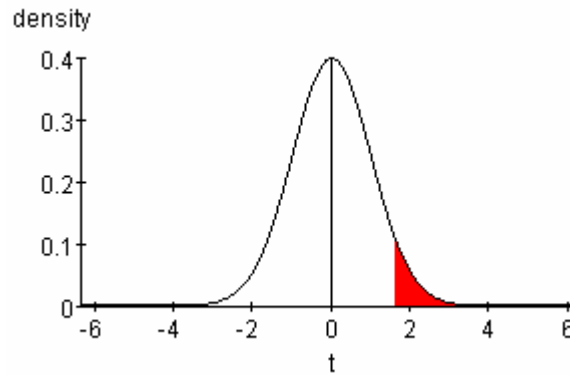

degrees of freedom = $2n - 2 = 170$ / probability = 5 %
 $t_{\text{critical}} = 1.654$

The higher the mean, the higher the disagreement with the statement

<u>Statement</u>	<u>Mean</u>
Q1 : The voting machines are easy to use.	1.26
<i>Significant Over (t = 2.18 or 1.53%)</i>	
Q4 : I prefer electronic voting in comparison to paper voting.	1.63
<i>Significant Over (t = 2.67 or 0.42%)</i>	
Q2 : The voting machines are precise.	2.21
<i>Not Significant Over... (t = 1.29 or 9.94%)</i>	
Q3 : Electronic voting is more trustworthy than paper voting.	2.53
<i>Significant Over... (t = 3.19 or 0.08%)</i>	
Q5 : The companies that manufacture the voting machines are trustworthy.	3.34
<i>Not Significant Over... (t = 0.60 or 27.47%)</i>	
Q7 : It is possible to manipulate votes cast with the voting machine.	3.49
<i>Significant Over... (t = 3.20 or 0.08%)</i>	
Q6 : If the electronic vote were printed and placed in a paper ballot box, the voting would become more trustworthy.	4.38
<i>Not Significant Over... (t = 1.10 or 13.64%)</i>	
Q8 : A paper vote has less chance of getting lost than an electronic vote.	4.72

(this page intentionally left blank.)

APPENDIX B – THE LEAN ENTERPRISE MODEL

Copyrighted product of the Lean Aerospace Initiative
Massachusetts Institute of Technology

Meta-Principles: Responsiveness to change and Waste Minimization

Enterprise Principles: Right thing at the right place, right time, and in the right quantity.

Effective relationships within the Value Stream

Continuous improvement

Optimal first delivered unit quality

1) Identify and Optimize Enterprise Flow

- Establish models and/or simulations to permit understanding and evaluation of the flow process.
- Reduce the number of flow paths.
- Minimize inventory through all tiers of the value chain.
- Reduce setup times.
- Implement process owner inspection throughout the value chain.
- Strive for single piece flow.
- Minimize space utilized and distance traveled by personnel and material.
- Synchronize production and delivery throughout the value chain.
- Maintain equipment to minimize unplanned stoppages.

2) Assure Seamless Information Flow

- Make Processes and flows visible to all stakeholders.
- Establish open and timely communications, among all stakeholders.
- Link databases for key functions throughout the value chain.
- Minimize documentation while ensuring necessary data traceability and availability.

3) Optimize Capability and Utilization of People

- Establish career and skill development programs for each employee.
- Ensure maintenance, certification and upgrading of critical skills.

- Analyze workforce capabilities and needs to provide for balance of breadth and depth of skills/knowledge.
 - Broaden jobs to facilitate the development of a flexible workforce.
- 4) Make Decisions at Lowest Possible Level
- Establish multi-disciplinary teams organized around processes and products.
 - Delegate or share responsibility for decisions throughout the value chain.
 - Empower people to make decisions at the point of work.
 - Minimize hand-offs and approvals within and between line and support activities.
 - Provide environment and well-defined processes for expedited decision-making.
- 5) Implement Integrated Product and Process Development
- Use systems engineering approach in product design and development.
 - Establish clear sets of requirements and allocate these to affected elements of the product and processes.
 - Definitize risk management.
 - Incorporate design for manufacturing, test, maintenance and disposal in all engineering phases.
 - Design in capability for potential growth & adaptability.
 - Establish effective IPTs.
 - Involve all stakeholders early in the requirements definition, design and development process.
 - Use the “Software Factory ” Process.
 - Implement design to cost processes.
 - Maintain continuity of planning throughout the product development process.
- 6) Develop Relationships Based on Mutual Trust and Commitment
- Provide for continuous information flow and feedback with stakeholders.
 - Optimize the contract process to be flexible to learning and changing requirements.
 - Create and maintain relationships with customers in requirements generation, product design, development and solution-based problem solving.
- 7) Continuously Focus on the Customer

- Provide for continuous information flow and feedback with stakeholders.
- Optimize the contract process to be flexible to learning and changing requirements.
- Create and maintain relationships with customers in requirements generation, product design, development and solution-based problem solving.

8) Promote Lean Leadership at All Levels

- Flow-down Lean principles, practices and metrics to all organizational levels.
- Instill individual ownership throughout the workforce in all products and services that are provided.
- Assure consistency of enterprise strategy with Lean principles and practices.
- Involve union leadership in promoting and implementing Lean practices.

9) Maintain Challenge of Existing Processes

- Establish structured processes for generating, evaluating and implementing improvements at all levels.
- Fix problems systematically using data and root cause analysis.
- Utilize cost accounting/management systems to establish the discrete cost of individual parts and activities.
- Set jointly-established targets for continuous improvement at all levels and in all phases of the product life cycle.
- Incentivize initiatives for beneficial, innovative practices.

10) Nurture a Learning Environment

- Capture, communicate and apply experience-generated learning.
- Perform benchmarking.
- Provide for interchange of knowledge from and within the supplier network.

11) Ensure Process Capability and Maturation

- Define and control processes throughout the value chain.
- Establish cost beneficial variability reduction practices in all phases of product life cycle.
- Establish make/buy as a strategic decision.

12) Maximize Stability in a Changing Environment

- Level demand to enable continuous flow.
- Use multi-year contracting wherever possible.
- Minimize cycle-time to limit susceptibility to externally imposed changes.
- Structure programs to absorb changes with minimal impact.
- Establish incremental product performance objectives where possible.
- Program high risk developments off critical paths and/or provide alternatives.

APPENDIX C – LEVI ELABORATED

The developers of the Low Error Voting Interface (LEVI) [19] experimented with various user interface prototypes to generate data on voter interaction with voting machines. This helped them define what they believe to be important characteristics for a low-error user interface. They observed that the voter should always know:

1. Which races still require voting.
2. Whether a selection was made in a particular race.
3. What selection was made in each race.

LEVI was designed to clearly provide all three voter information criteria. A system of pages and tabs was used in LEVI to simultaneously show all ballot races on the screen. A fisheye function could be employed to allow many races to be shown at once. In such a way, the voter can easily locate races that haven't been addressed – answering the first criterion.

By changing the color of the tab when a vote is cast for a particular race, LEVI easily reflects whether a selection has been. The color change can be supplemented by a texture change, which is useful for the colorblind. This color and/or texture indication, therefore, answers the second criterion.

Once the voter has made a selection in a certain race, the chosen option appears on the corresponding tab. In this way, LEVI is able to not only tell voters which races they have voted on, but also what selections they have made in each race. This satisfies the third information criterion

After developing a user interface prototype that answers the criteria mentioned above, the developers were able to conduct experiments to evaluate improvements in error-rates. Results from quantitative experiments can be seen in the main text (pgs. 58-59)